

AF-3400s, AF-3500s, AF-4500s

EFIS System - Engine Monitoring System – Moving Map



Patents 6,271,769 B1 and 6,940,425

User Guide and Installation Manual

Version 7.6

11/21/2019

IMPORTANT PRE-INSTALLATION NOTICE

Before installing the monitoring system, READ THE LIMITED WARRANTY / AGREEMENT. There is information in the Limited Warranty / Agreement that may alter your decision to install this product. IF YOU DO NOT ACCEPT THE TERMS OF THE LIMITED WARRANTY / AGREEMENT DO NOT INSTALL THE PRODUCT. The product may be returned for a refund if you do not accept the terms of the Limited Warranty / Agreement.

Before starting the installation, make sure that your planned installation will not interfere with the operation of any controls. The installer should use current aircraft standards and practices to install this product. Refer to AC 43.13-2A, *Acceptable Methods, Techniques, and Practices - Aircraft Alterations* and AC 43.13-1B, *Acceptable Methods, Techniques, and Practices--Aircraft Inspection and Repair*.

Experimental instrument limited to use in experimental aircraft.



AF-3400s, AF-3500s, AF-4500s Post Installation Check



CAUTION: Do not fly the aircraft until the following check list has been completed.

Never Power the system with an automotive battery charger and the aircraft battery disconnected.

Before Power is Applied for the First Time

- Screen mounted following the installation manual
- Magnetometer mounted (Label up, connector forward)
- Screen case has been properly grounded using center case screw
- Wiring harness is properly connected to screen
- Verify relay protection diodes are installed on all large aircraft relays (Master, Starter, Avionics...etc)
- Pitot/Static and AOA plumbing is secured to the correct ports on the screen
- Trim Servo indication wires are connected per the installation manual wiring diagram

Applying Power for the First Time

- Turn on aircraft battery power and power on the screens on.
- Verify the unit powers up; read the warning message where the **I AGREE** button is displayed. This page contains the software version installed along with any mapping effective/expiration dates.
- Set your clock time-zone offset
- Set the AHRS Pitch Adjust for your aircraft's panel tilt (0 or 8 degrees typically)
- Following the installation manual, calibrate the Fuel Tanks
- Following the installation manual, calibrate all trim and flap position sensors
- Set the airspeed V speeds based on your **aircraft manufacturers** recommendations.
- Set all engine temperatures/limits based on your **engine manufacturers** recommendations
- Set fuel tank, fuel pressure, fuel pressure, oil temperature, and oil pressure warning parameters
- Configure your Serial Ports based on devices connected
- Configure your GPS/NAV Settings based on Serial Port selection
- Verify all GPS and NAV sources are properly communicating with the EFIS. See Appendix J: 430W - EFIS - Autopilot - ARINC Troubleshooting guide if you have an autopilot and/or a Garmin GNS-430W/530W.
- AOA Post-Installation Pre-Flight Checklist Completed

First Engine Start

- With relay protection diodes installed, your AFS screen(s) can be turned on before the engine is started.
- After the engine has started, verify oil pressure and temperature. If none is indicated **SHUT DOWN** the engine. Verify all wiring and consult your local A&P, the engine manufacturer, and/or AFS technical support.
- Verify all engine indications are correct per your **engine manufacturers** manual

Before First Flight

- Verify you have the latest system software and mapping data (if applicable) - Visit the AFS Website for latest software and map data.
- Weight & Balance page updated with **your** aircrafts data
- Checklist pages updated with information from your **aircraft manufacturer**
- Magnetometer Alignment completed on all screens with an AHRS installed (See video on AFS website Support Forum)
- EFIS AOA Calibration Checklist completed
- Pitot/Static check completed from an authorized FAA Repair Station.
- EFIS and autopilot gains are set per the installation manual

In-Flight Configuration

- Verify airspeed and altitude indicate correctly
- Verify heading indicates correctly using a backup whiskey compass for reference
- Test navigation sources and verify they function properly
- If an autopilot is installed and coupled to the EFIS, check its functions

After First Flight

- Calibrate Fuel Flow K-Factor (See Installation Manual)



AOA FLIGHT WARNING:

The EFIS may be shipped with AOA aircraft calibration data pre-installed. If you choose to use this data, you must verify the validity of the data or calibrate the AOA to meet your specifications before using. You must also read and understand the separate AOA manual before using the AOA instrument in flight.

LIMITED WARRANTY / AGREEMENT

Advanced Flight Systems Inc. ("AFS") warrants its aircraft monitoring system instrument and system components to be free from defects in materials and workmanship for a period of one year commencing on the date of the first flight of the instrument or one year after the invoice date, whichever comes first. AFS will repair or replace any instrument or system components under the terms of this Warranty provided the item is returned to AFS prepaid.

This Warranty shall not apply to any unit or component that has been repaired or altered by any person other than AFS, or that has been subjected to misuse, abuse, accident, incorrect wiring, or improper or unprofessional installation by any person. THIS WARRANTY DOES NOT COVER ANY REIMBURSEMENT FOR ANYONE'S TIME FOR INSTALLATION, REMOVAL, ASSEMBLY OR REPAIR. AFS reserves the right to determine the reason or cause for warranty repair.

1. This Warranty does not extend to any engine, machine, aircraft, boat, vehicle or any other device to which the AFS monitoring system may be connected, attached, or used with in any way.
2. THE REMEDIES AVAILABLE TO THE PURCHASER ARE LIMITED TO REPAIR, REPLACEMENT, OR REFUND OF THE PURCHASE PRICE OF THE PRODUCT, AT THE SOLE DISCRETION OF AFS. CONSEQUENTIAL DAMAGES, SUCH AS DAMAGE TO THE ENGINE OR AIRCRAFT, ARE NOT COVERED, AND ARE EXCLUDED. DAMAGES FOR PHYSICAL INJURY TO PERSON OR PROPERTY ARE NOT COVERED, AND ARE EXCLUDED.
3. AFS is not liable for expenses incurred by the customer or installer due to AFS updates, modifications, improvements, upgrades, changes, notices or alterations to the product.
4. The pilot must understand the operation of this product before flying the aircraft. Do not allow anyone to operate the aircraft that does not understand the operation of the monitoring system. Keep the operating manual in the aircraft at all times.
5. AFS is not responsible for shipping charges or damages incurred during shipment.
6. No one is authorized to assume any other or additional liability for AFS in connection with the sale of AFS products.
7. IF YOU DO NOT AGREE TO ACCEPT THE TERMS OF THIS WARRANTY, YOU MAY RETURN THE PRODUCT FOR A FULL REFUND. IF YOU DO NOT AGREE TO ACCEPT THE TERMS OF THIS WARRANTY, DO NOT INSTALL THE PRODUCT.
8. This warranty is made only to the original purchaser and is not transferable. THIS WARRANTY IS IN LIEU OF ALL OTHER WARRANTIES OR OBLIGATIONS, EXPRESS OR IMPLIED, ORAL OR WRITTEN. AFS EXPRESSLY DISCLAIMS ALL IMPLIED WARRANTIES OF MERCHANTABILITY OR FITNESS FOR A PARTICULAR PURPOSE. THE PURCHASER AGREES THAT IN NO EVENT SHALL AFS BE LIABLE FOR SPECIAL, INCIDENTAL OR CONSEQUENTIAL DAMAGES, INCLUDING DAMAGES TO THE ENGINE OR AIRCRAFT, LOST PROFITS, LOSS OF USE, OR OTHER ECONOMIC LOSS. EXCEPT AS EXPRESSLY PROVIDED HEREIN, AFS DISCLAIMS ALL OTHER LIABILITY TO THE PURCHASER OR ANY OTHER PERSON IN CONNECTION WITH THE USE OR PERFORMANCE OF AFS' PRODUCTS, INCLUDING BUT NOT LIMITED TO STRICT PRODUCTS LIABILITY IN TORT.

THIS PAGE INTENTIONALLY LEFT BLANK

Table of Contents

AF-3400s, AF-3500s, AF-4500s Post Installation Check	2
LIMITED WARRANTY / AGREEMENT	3
INTRODUCTION	9
SYSTEM OPERATION	11
Power On / Off	11
Battery Operation	11
Screen Selection	12
Enable/Disable Pages	13
Knob List Configuration	13
EFIS Flight Display	14
AHRS Alignment (Gyro)	14
Dual AHRS Monitoring	14
Screen Dimming	15
Barometric Pressure/Altitude	15
Airspeed	15
Horizon Roll and Pitch	15
Altitude	15
Heading – EFIS DG	15
Skid/Slip Ball (Inclinometer)	16
Standard Rate Turn Indicator	16
Vertical Speed	16
G-Meter	16
Flight Path Marker	16
EFIS Bugs (Airspeed, Altitude, Minimum Alt, Heading)	17
Clock/Timer Operation	18
Angle of Attack (AOA)	20
EFIS AOA CALIBRATION CHECK LIST	22
Synthetic Vision	24
Terrain Awareness and Warning System (TAWS)	24
Highway in the Sky (HITS)	26
EFIS Navigation (HSI)	28
GPS Navigation Display	28
VOR Navigation Display	31
Internal Flight Planning	33
Autopilot Control / Flight Director	34
Autopilot / Flight Director Control Settings	37
The ABOUT Page	42
Moving Map Display	43
Map Features	43
Map Data Source	44
Private Airports	44
Intersections	44
Zoom Range	44
Nearest Airport	44
Direct To Navigation	44
Airport Info	44
Airspace	44
Track Mode	44

Map Database Files	45
Traffic Display	47
Zaon XRX	48
Garmin GTX-330	48
NavWorx ADS-B	49
To prevent seeing yourself called out as traffic (ghosting), connect one of the Serial outputs of the GTX-330 configured as REMOTE + TIS to Pin 33 of the ADS600-B box. Send the following command to the ADS600-B. TXCP GTX330 or TXCP GTX327.	49
uAvionics Echo	50
73,102 Dynon SV-GPS-250 Connections	51
Garmin GTS-8xx TCAS System	52
Weather Display	53
XM Weather	55
ADS-B Weather	56
IFR Approach Plates	58
Engine Monitor Display	59
Fuel Computer	59
Fuel Flow Calibration	60
% Power Display	61
EGT/CHT Display Modes	62
Flight Times	63
Check Lists	63
Maintenance Log	64
Weight & Balance Screen	65
Flight Data Logs	67
Importing Flight Data to Excel	67
<i>AF-3400/AF-3500/AF-4500 Installation</i>	68
Mechanical Mounting	68
Electrical Connections	69
Audio Connections	69
Volume Adjustment	69
EFIS Serial Data Connections	70
Serial Port # Function Hardware Setup	70
GPS/NAV # Data Source Software Setup	71
EFIS Serial Port Configuration Examples	72
External Device Configuration	74
AF-ARINC 429 ADAPTOR	74
CO Guardian Display	74
Garmin 430W/530W	74
ARINC Module Software Updating	76
Garmin SL-30	77
Garmin 396/496	77
Garmin GTX 327 / GTX 330 Transponder	77
Chelton or OP EFIS	77
Magnetometer Installation	78
Magnetometer Alignment	79
Outside Air Temperature Transducer Installation	79
Alarm Output	79
EGT/CHT Installation	80

Propeller RPM Sensor Installation _____	81
_____	81
Oil Temperature Sensor Installation _____	81
Amp Transducer Installation _____	82
Pressure Transducer Installation _____	83
Oil Pressure Transducer Installation _____	83
Fuel Pressure Transducer Installation _____	83
Fuel Flow Transducer Installation _____	84
Manifold Pressure Transducer Installation _____	85
Fuel Tank Level Sensor _____	86
Float Type _____	86
Capacitance Type _____	86
_____	86
Trim & Flap Position Installation _____	86
<i>Instrument Calibration</i> _____	87
Airspeed Color Range Settings _____	88
Altimeter Check _____	88
RPM Calibration _____	89
Fuel Tank Calibration _____	89
Trim/Flap Calibration _____	90
Test Audio _____	90
Switch Inputs _____	91
<i>Administrative Settings</i> _____	92
System Files _____	92
Multiple Screen Setup _____	93
Dual AHRS Configuration _____	93
<i>APPENDIX A: Specifications</i> _____	95
Physical _____	95
Power Requirements _____	95
SD Card _____	95
AF-3400/AF-3500 Non-S Clock Battery _____	95
Backup Battery _____	95
<i>APPENDIX B: Hardware Specifications</i> _____	97
AF-4500s Tray Mounting & ARINC Adapter _____	99
99	
99	
<i>APPENDIX C: Electrical Connections</i> _____	100
<i>APPENDIX D: Metric Units</i> _____	102
<i>APPENDIX E: Software Updates</i> _____	103
<i>APPENDIX F: EFIS Activation Keys</i> _____	104
<i>APPENDIX G: Aerosance FADEC Interface</i> _____	105

APPENDIX H: Eagle EMS Interface	106
APPENDIX I: AOA Pressure Port Location	107
APPENDIX J: Troubleshooting	108
GNS-430W/530W - EFIS - Autopilot - ARINC Interface Troubleshooting	109
109	
APPENDIX K: Vertical Power VP-X/PRO Interface	114
APPENDIX L: Flight Director/AF-Pilot Procedures flying an Approach	115
Flying an LPV Approach	115
Flying an ILS Approach	119
APPENDIX M: SCHEMATICS	120
123	
Registration Information	124

MANUAL REVISION HISTORY

REVISION	DATE	DESCRIPTION
6.7	2010	Updated Calibration Menu access
7.0	07/13/10	Updated for new "s" CPU with Synthetic Vision updated autopilot control
7.1	10/19/10	Updated post-installation checklist Updated Weather & Traffic features Updated Trim & Flap indication calibration procedure Updated autopilot gain settings
7.2	01/05/2011	Updated ADS-B traffic functions Added several screenshots Added wiring to prevent ghost traffic
7.3	09/01/2011	Updated ADS-B wiring Added Appendix H: EagleEMS Added GTS-8xx TCAS System to Traffic Display section Added HITS and Internal Flight Plan sections
7.4	03/12/2012	
7.5	11/21/2016	Fixed clock battery specification
7.6	11/22/2019	Dynon SV-GPS-250 Wiring

INTRODUCTION

Advanced Flight Systems Inc. manufactures three different size EFIS and Engine Monitor systems. The AF-3400 uses a 6.5" display and the AF-3500 and AF-4500 use an 8.4" display. The new "s" CPU systems utilize our new high speed CPU and support Synthetic Vision. The systems can be purchased as an EFIS only "EF", Engine Monitor only "EM", Multi Function Display "MFD", or as a single screen with both EFIS and Engine Monitor boards installed "EE". Multiple systems can be easily connected to share all data between screens. Install an EFIS "EF" and an Engine Monitor "EM" screen and you will have the ability to display flight and engine instruments on both screens. Our EFIS Systems utilize a Crossbow AHRS which is an AFS customized version of the certified Crossbow AHRS500.



WARNING

It is possible for any instrument to fail and display inaccurate readings. Therefore, you must be able to recognize an instrument failure and you must be proficient in operating your aircraft safely in spite of an instrument failure. If you do not have this knowledge, contact the FAA or a local flight instructor for training. The ability for this product to detect a problem is directly related to the pilot's ability to program proper limits and the pilot's interpretation and observation skills. The pilot must understand the operation of this product before flying the aircraft. Do not allow anyone to operate the aircraft that does not know the operation of this product. A copy of this manual must be kept in the aircraft at all times.

The AF-3400/3500/4500 will automatically turn on any time power is applied to the unit.

NOTE: The system is designed to remove a gauge needle from the screen if a transducer is disconnected.

Each gauge can have an upper and lower **caution** and **warning** limit. If a gauge is in the **caution** area the needle and value will turn yellow. If a gauge is in the **warning** area the needle and value will turn red.

If the engine RPM is greater than 500rpm and a gauge is in the **warning** area the gauge name will be displayed over button 1 in red and an audible warning will be generated. For example if the oil pressure is low you should hear "Check Oil Pressure", this will repeat every 5 seconds until the gauge is no longer in the warning area or you press button 1 to acknowledge the error and stop the audible warning for that gauge.

The system will give the audible warning "Check Fuel Computer" on startup if the fuel computer's gallons remaining value does not match the fuel tanks level. This feature (if turned on in Instrument Calibration) should warn you if you have added fuel and forget to adjust the fuel computer. The number of gallons that will generate an error is adjusted in Instrument Calibrate. Since the fuel levels are NOT accurate when the tanks are near full this value is doubled when the tanks show full.

See Instrument Calibration for directions on setting the upper and lower **caution** and **warning** limits.

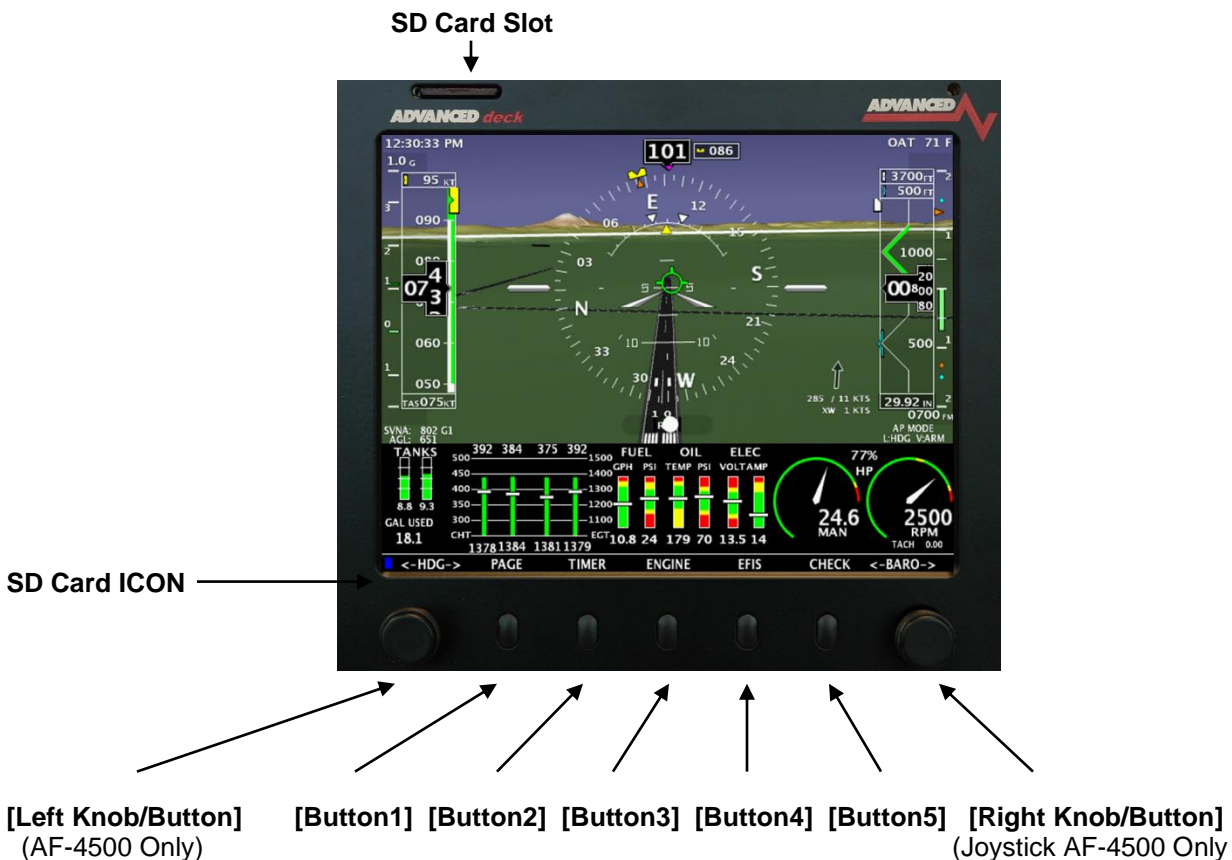

Knobs and Buttons

The **AF-3400** and **3500** have 5 buttons and one rotary knob with a push button for data input.

The **AF-4500** has a left rotary knob, 5 buttons and one rotary/joy stick knob on the right side with a push button for data input.

Screen Selection

You can rotate through the enabled screens on the unit by pressing the [PAGE] button.



EFIS



EFIS & EMS

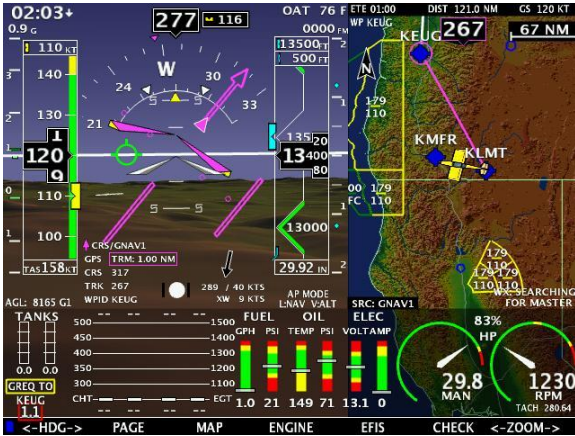

EFIS - EMS - MAP



EFIS & MAP

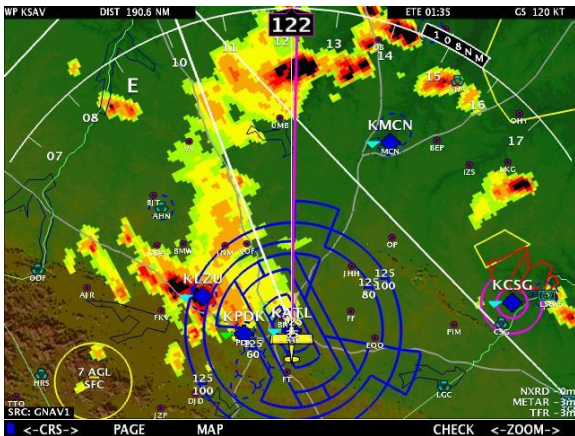

MAP

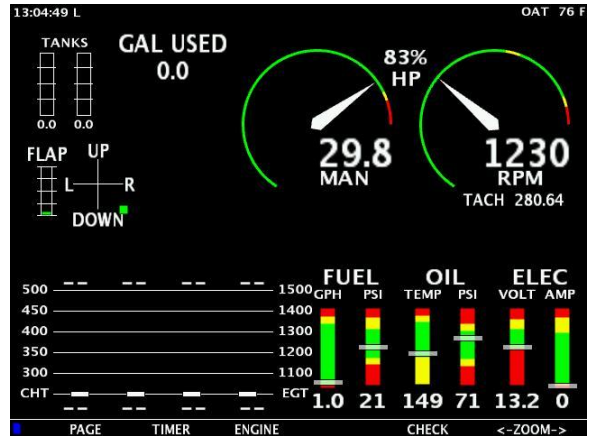

EMS



Six-Pack Panel Page ("s" CPU)



AIR and EMS (non "s" CPU only)

Enable/Disable Pages

You can select what pages are in the screen rotation from the [EFIS] -> [Settings] -> [More] menu by pressing the <Page List> knob button. The knob is used to enable or disable each item. After selecting the desired pages be sure and press the [SAVE] button. Some pages on the list may be grayed out if you didn't purchase those features or disabled them in the Calibration Menu (MAP & VPX).



Knob List Configuration

You can select which items appear on the knob pop up list when you press the knob button from the [EFIS] -> [Settings] -> [More] -> [Page List] -> [Knob List] menu. The knob is used to enable or disable each item. After selecting the desired items be sure and press the [SAVE] button. Some items will appear on the list on certain pages even when turned off; DIM is always available on the checklist page, ZOOM is always available on a map page.

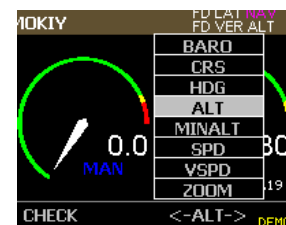

The knob pop-up menu selection can be configured for PUSH SEL (press the knob to select next item in list) or TURN SEL (turn the knob to select item in list) from the KNOBLIST menu.

EFIS Flight Display



AHRS Alignment (Gyro)

When power is applied to the system the EFIS display will have a large **RED X** while the AHRS is initializing. The Aircraft should not be moved until the **RED X** disappears from the Screen (Approximately 40 seconds).

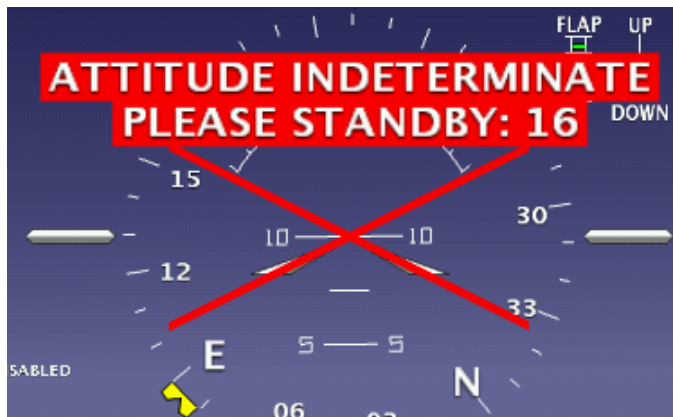

CAUTION:

If for any reason the **RED X** appears on the screen the Horizon Attitude, Heading, and Slip display **MUST NOT BE RELIED ON FOR PRIMARY NAVIGATION**.



Dual AHRS Monitoring

If you have a dual screen system with two AHRS units you can configure the screens to monitor both AHRS units. If a screen detects that there is an AHRS mismatch error in Roll, Pitch, or Heading you will get an AHRS MISMATCH error displayed on the center of the screen. See Dual AHRS configuration for proper setup.

Screen Dimming

The screen can be dimmed from the Checklist page by turning the right knob anytime the word **DIM** is displayed. If **DIM** is not displayed press the knob and select **DIM** from the list.



Barometric Pressure/Altitude

The current barometer setting is displayed in the box below the altitude tape. The value is shown in either inches of Mercury or millibars. The current barometer setting can be adjusted by turning the knob anytime the word **BARO** is displayed. If **BARO** is not displayed press the knob until it is displayed. The current field elevation is stored in memory so that the altitude should be correct on power on.

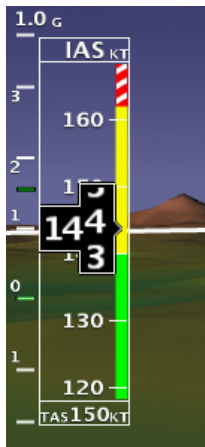

Airspeed

The airspeed is displayed on the left side of the screen using an analog 4 colored tape and digital readout. The airspeed range marks can be adjusted in Instrument Calibration under Airspeed. The airspeed units are displayed in both the upper Indicated Airspeed box and the lower True Airspeed box. A barber pole style hash will automatically show above Vne.

Horizon Roll and Pitch

The horizon (roll and pitch) works the same way that you would expect a traditional artificial horizon to work. The white zero pitch line stays parallel to the actual horizon regardless of the aircraft's pitch and roll. If you have the new "s" CPU and have the SV enabled you will notice that the zero pitch line is not always on the horizon. If the display is showing terrain above the zero-pitch line, your aircraft is below the upcoming terrain.

The parallel lines above and below the horizon line are the pitch indicator lines. Similarly the arrow rotating around the roll indicator gives you visual representation of your current roll angle. Each mark represents 10 degrees of roll with longer marks at 0, 30, 45, and 60. The pitch line can be adjusted for level flight from the main EFIS page by pressing the following buttons [EFIS] -> [SETTINGS] -> [PITCH ADJ] The right knob is then used to adjust for level flight pitch.

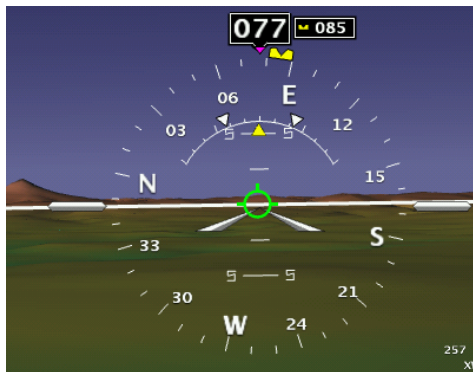

Altitude

The altitude tape gives you a visual representation of your altitude. The digital readout points to your current altitude, thousands of feet are displayed using large numbers while hundreds of feet are displayed using smaller numbers. The green chevrons are located at 1000' intervals for IFR cruising altitudes and the white chevrons are located at 500' indicating VFR cruising altitudes. Above the tape are two boxes showing the value of the two altitude bugs. The main ALT bug is for the Flight Director altitude pre-select. Its altitude is shown in the upper box. The lower box displays altitude for the MIN ALT bug which is used to program a DH/MDA for an IFR approach.



Heading – EFIS DG

This heading is displayed like a standard slaved directional gyro. The digital readout in the pointer shows your current heading. If



the EFIS DG is red, the heading should not be relied on and you should check the magnetometer wiring.

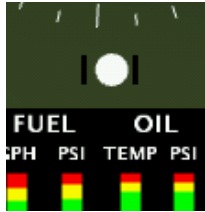

Skid/Slip Ball (Inclinometer)

The skid/slip ball works like any standard mechanical gauge. If the ball is within the black lines, then you are in coordinated flight. The ball on the outside of a turn indicates a skid, while the ball on the inside of a turn indicates a slip.

Standard Rate Turn Indicator

The required bank angle for a standard rate turn is indicated by a white triangle on the roll scale. If you align the yellow bank angle pointer with one of the white triangles you should complete a 180° turn in 1 minute. The required bank angle will change with airspeed and the triangles will disappear below 30 kts.



Vertical Speed

The vertical speed is displayed using a green bar located on the right side of the altimeter tape. The bar will increase upward for climbing flight and increase downward for descending flight. The digital vertical speed will be displayed on the top of the gauge in a climb and on the bottom of the gauge for a descent.

G-Meter

The G-Meter is located next to the Airspeed tape. The current G loading will be displayed with a green bar. The G-Meter options are selected from the following menu:

[EFIS] -> [G METER]

From the G Meter menu you can:

Turn the G Meter On/Off

Reset the G Meter.

The G Meter is limited to +/- 5 G's and will record the maximum and minimum G's that the aircraft has seen since the last time the Reset button was pressed with a green marker on the scale.



Flight Path Marker

The green flight path marker (FPM) or velocity vector shows where the aircraft is actually moving. Think of it as a visual representation of GPS Track. The green target will only be centered under steady state flight conditions with no wind. Usually the target will be moving around the display showing where the airplane



is going, not where the nose is pointed. If you have a strong cross wind from the left you will see the FPM move to the right. If you keep the FPM on the horizon line you will maintain level flight, even during steep turns. The FPM requires a valid GPS signal be present and Synthetic Vision enabled. The FPM will be red if there is no GPS signal or there is not enough room on the screen to show the FPM deviation.



EFIS Bugs (Airspeed, Altitude, Minimum Alt, Heading)

Altitude Bug

The Altitude Bug can be turned on and off from the [EFIS] -> [NAVIGATION] -> [BUGS] -> [ALT] menu. If the Altitude Bug is on and the text over the knob is <-ALT-> the knob will set the desired altitude bug location. If the text is not <-ALT-> you should press the knob button until it appears. Holding the knob down for two seconds will sync the altitude bug to the current altitude. The box on the top of the altitude tape shows the current bug location and will have a black background when selected.

Altitude Alerting

The Altitude Alerting function provides visual and voice "ALTITUDE" alerts when approaching the Altitude Bug.

- Upon passing through 100 feet of the Selected Altitude, the Altitude Bug changes from White to Yellow
- When the aircraft passes within 200 ft of the Selected Altitude, the Altitude Bug changes from Yellow to Cyan, and the voice alert "ALTITUDE" is generated.
- After reaching the Selected Altitude the pilot flies outside of the deviation band (± 200 feet of the Altitude Bug), the Altitude Bug changes from Cyan to Yellow, and the voice alert "ALTITUDE" is generated.

Altitude > 1000' of Bug



1000' > Altitude > 200' of Bug



Altitude < 200' of Bug



Minimum Descent Altitude/Decision Height Bug

A barometric Minimum Descent Altitude Bug (MDA, or Decision Height, DH) is displayed whenever the altitude bug is turned on. If the MDA Bug is on and the text over the knob is <-MIN ALT-> the knob will set the desired MDA bug location. If the text is not <-MIN ALT-> you should press the knob button until it appears. Holding the knob down for two seconds will sync the bug to the current altitude. The second box on the top of the altitude tape shows the current bug location and will have a black background when selected.

MDA/DH Alerting

The MDA Alerting function provides visual and voice "MINIMUMS" alerts when approaching the Bug.

- Upon passing through 100 feet of the Selected Altitude, the Bug changes from Cyan to White.
- After reaching the Selected Altitude the Bug changes from White to Yellow, and the voice alert "MINIMUMS" is generated.

MDA Bug



Altitude > Altitude



100' of MDA Bug



100' > Altitude > "MIMIMUMS"



Airspeed Bug

The Airspeed Bug can be turned on and off from the **[EFIS] -> [NAVIGATION] -> [BUGS] -> [SPD]** menu. If the Airspeed Bug is on and the text over the knob is **<-SPD->** the knob will set the desired airspeed bug location. If the text is not **<-SPD->** you should press the knob button until it appears. Holding the knob down for two seconds will sync the airspeed bug to the current airspeed. The box on the top of the airspeed tape shows the current bug location and will have a black background when selected

Heading Bug

The Heading Bug can be turned on and off from the **[EFIS] -> [NAVIGATION] -> [BUGS] -> [HDG]** menu. If the Heading Bug is on and the text over the knob is **<-HDG->** the knob will set the desired heading bug location. If the text is not **<-HDG->** you should press the knob button until it appears. Holding the knob down for two seconds will sync the heading bug to the current magnetic heading. The text next to the heading box shows the current bug location and will have a black background when selected.



The knob and joystick on the AF-4500 can be used as a shortcut for HDG & CRS, ALT & VS. If the ALT bug is changed and then the joystick is pressed in, the VS function will automatically become active. If the VS is not changed, the joystick function will return to normal after 2 seconds. This feature also applies to the left knob. When HDG is changed, the knob can be pressed within 2 seconds to automatically change the function to CRS. After 2 seconds of no activity, normal knob functionality will be restored.

Clock/Timer Operation

The time functions can be accessed from the main screen by pressing the **[TIMER]** button.

Clock Setting

Press the **[CLOCK]** then **[SET]** buttons to enter the date/time adjustment menu. The knob is used to adjust each field and the knob is pressed to advance to the next field. First set the time in Zulu format, then the date, and finally the last field is your local time offset.

Timer Functions

The system has a count-down and count-up timer that is accessed by pressing the **[TIMER]** button in the main menu. The timer value is adjusted with the knob and controlled using the buttons:

[START] [STOP] [RESET] [UP/DWN] [ADJ]

The Up or Down mode is displayed with an arrow on the screen. If Count Down mode is selected, the right knob is used to set the starting time. The timer display will flash green when 0:00 is reached and you will get the voice alert "TIMER". The RESET button acts differently based on Timer mode. In Count Down

mode, the RESET button will reset the time to the last programmed time. In Count Up mode, the RESET button will change the timer to 0:00.

Once the timer is activated it is displayed on the upper left corner of the screen replacing the clock. The clock can be returned by pressing **[TIMER]** then **[CLOCK]** buttons.

Dual Screen Clock Setting

The current time on the other screen can be set by pressing the **[NET SYNC]** button from the time menu on the current display. When you press the **[NET SYNC]** button the time is sent over the Ethernet connection to the other screen and its clock is set to match the current screen.

Angle of Attack (AOA)

See Appendix I: AOA Pressure Port Location

The EFIS can display an AOA if you have installed the optional AOA system. You will need to perform an in flight AOA calibration if your unit has not been loaded with precalibrated AOA data.

The AOA in flight settings can be adjusted from following Menu:

[EFIS] -> [SETTINGS] -> [AOA]

Button 2 in the AOA menu controls the AOA display.

OFF The AOA display is always off

ON The AOA display is always on

DECLUTTER The AOA display will be on if the angle of attack is greater than the AOA declutter segment in the EFIS AOA calibration menu. We have found the ideal setting for declutter is 8.

The segments are numbered using the following:

- 23 Warning - RED Only
- 16 Approach - Yellow lined up with the center of the donut
- 12 L/D Max - Split Green bar
- 6 Bottom Green Bar.

Flap Sensor

The AOA indicator can use either the flap position sensor for the screen or the supplied switch connected to Input #3 on the main EFIS harness. The AOA "Use Flap Angle Sensor" should be set to YES if you have installed the Linear Flap Position Sensor for the screen in Instrument Calibration.

4. AOA

- | | |
|---------------------------|--------|
| 13. Use Flap Angle Sensor | YES/NO |
| 16. Declutter Segment | 8 |

AOA Display

The center round donut will be green when the flaps are down and black when they are up. For a detailed explanation of the AOA system please refer to the separate AOA manual and the EFIS AOA Calibration Checklist. The numbers below the display are degrees angle of attack in tenths. If the AOA is properly calibrated you should get the following displays. As your angle of attack increases the display will lose bars.



L/D Max

This is the best engine out glide AOA.



Approach

This is the desired AOA for a normal approach.

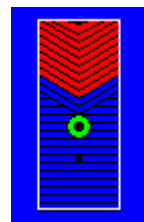

Warning

This should indicate that you are 15% above stall and you will get the verbal "Angle Angle Push".

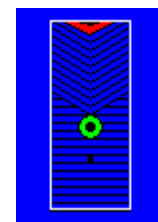

STALL

This should indicate just as you reach the stalling AOA

THIS PAGE INTENTIONALLY LEFT BLANK

EFIS AOA CALIBRATION CHECK LIST

EFIS_cklst.doc 09/2010 rev 3
paper color Green



POST INSTALLATION PRE FLIGHT

Blow into Blue tube at CPU ----- Air exits Upper Wing Port
Blow into Green tube at CPU ----- Air exits lower Wing Port
PITOT/STATIC LEAK TEST ----- COMPLETED
AIRCRAFT LOG ----- UPDATED
AIRCRAFT CHECKLISTS ----- UPDATED
ANNUAL CONDITION C/L ----- UPDATED
CHAPTER IX TESTING ----- COMPLETED

HANGAR CALIBRATION

The only thing that is required for the EFIS AOA is to check the flap switch.

FLAPS UP DONUT CHECKED OFF
FLAPS DOWN DONUT CHECKED ON

CRUISE CONFIGURATION CALIBRATION

AIRCRAFT LOCATION..... AIRBORNE
FLAPS/GEAR..... CONFIRMED UP
EFIS AOA DISPLAY ON ON
AOA Calibrate Menu EFIS -> SETTINGS ->
AOA -> AOA CAL..... PUSH/RELEASE
CONFIRM flap up calibrate page 0OL
ZERO “G” MANEUVER for 1/2 sec..... YES
RECORD button..... PUSH/RELEASE
CONFIRM flap up angle advisory page 0AA
AIRSPEED 1.15V_{S1} descending slow flight YES
RECORD button PUSH/RELEASE
PAGE button 2x PUSH/RELEASE
CONFIRM save data to non-volatile memory page 0SA
RECORD button..... PUSH/RELEASE

YOU ARE NOW IN THE FLIGHT MODE

LANDING CONFIGURATION CALIBRATION

AIRCRAFT LOCATION..... AIRBORNE
FLAPS/GEAR..... CONFIRMED DOWN
EFIS AOA DISPLAY ON ON
AOA CAL Button PUSH/RELEASE
CONFIRM flap down calibrate page 1OL
ZERO “G” MANEUVER for 1/2 sec..... YES
RECORD button..... PUSH/RELEASE
CONFIRM flap down angle advisory page..... 1AA
AIRSPEED 1.15V_{SO} descending slow flight YES
RECORD button..... PUSH/RELEASE
PAGE button 2x PUSH/RELEASE
CONFIRM save data to non-volatile memory page 1SA
RECORD button..... PUSH/RELEASE

YOU ARE NOW IN THE FLIGHT MODE

FLIGHT TEST AOA

VERIFICATION C/L ----- COMPLETE
CHAPTER X CALIBRATING ----- COMPLETE
CHAPTER X FLIGHT TESTING --- COMPLETE

FLY THE AIRPLANE & WATCH FOR TRAFFIC!

The POST INSTALLATION and HANGAR CALIBRATION CHECK LISTS must be completed prior to flight. The zero “G” maneuver requires that all unsecured items be removed from the aircraft prior to flight. Two pilots are required during the calibration process and one will be assigned the task to fly the aircraft and nothing more. The flight calibration area will be cleared for traffic and will be at a safe altitude with the IAS always within the green IAS band. Stalls are not required or desired!

Push button in for 1/2 second and then releasing the button is proper button technique.

THIS PAGE INTENTIONALLY LEFT BLANK

Synthetic Vision

Synthetic Vision (SVN) gives users a forward looking perspective of the terrain ahead. This includes mountains, rivers/waterways, obstacles and runways. The Synthetic Vision database requires a Map Data card be installed in the unit. While the mapping option isn't necessary for SVN to work, the two share the same databases on the Map Data card. Grid lines are displayed on the ground of SVN. They are 1 arc minute lines, meaning at the equator they are 1nm by 1nm squares. As the aircraft is positioned farther North or South of the equator, the East/West lines of the grid are drawn closer together.

Note: Having synthetic vision changes the way the attitude indicator behaves; users will want to spend time flying with SVN in visual conditions before attempting to fly in IMC.

The biggest change new SVN users will notice is the lack of a definite horizon like a standard attitude indicator. Attitude indicators traditionally represent level flight when the miniature airplane is on the intersection of the blue and brown shading. Since in real life the aircraft is not level with the horizon in level flight, a synthetic **zero pitch line** has to be displayed over the primary flight display. This zero pitch line is shown as a thin white line extending from the left side of the PFD page all the way to the far right side of the PFD page.

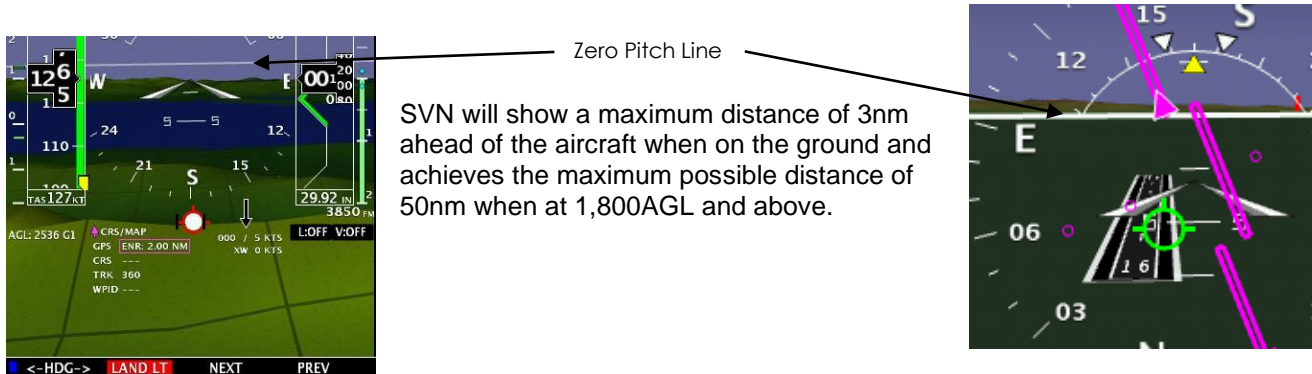

Synthetic Vision Settings

Enable/Disable - Press EFIS -> SETTINGS -> MORE -> ON/OFF

- Instrument Calibration:* 35: Synthetic Vision
1. Synthetic Vision ON/OFF - Enables/Disables SVT (if the software key is installed)
 2. Altitude Source - (AUTO, GPS ONLY, BARO ONLY) - Selects the altitude source for SVN

Terrain Awareness and Warning System (TAWS)

TAWS is a system designed to keep the pilot alert of altitudes that could result in Controlled Flight into Terrain (CFIT). Terrain is shaded in yellow or red based on the altitude of the aircraft and the altitude of the terrain below. When the distance between the aircraft and terrain below becomes close enough to present a conflict, the terrain is colored yellow or red. TAWS is drawn in a 6nm square around the aircraft.

When enabled, TAWS arms automatically when climbing through 1,200ft AGL. This is to prevent false warnings in the traffic pattern. TAWS is disabled when the aircraft slows to the shutoff speed set in Instrument Calibration under



TAWS Terrain Colors:

RED - Aircraft is within 100ft AGL of the terrain

YELLOW - Aircraft is between 1,000ft AGL and 100ft AGL of the terrain.

TAWS Settings

Instrument Calibration: 35: Synthetic Vision

3. Terrain Warning (TAWS) ON/OFF - Enables/Disables terrain shading based on altitude

4. TAWS Airspeed Shutoff (KTS) - Sets the airspeed at which TAWS is disabled (for landing).

Traffic Display

If a traffic device is connected to your EFIS monitor, the traffic will be displayed on the SVN. Traffic shown must be within 6nm of your aircraft and within the 60 degree view cone of the SVN 30 degrees on either side of your current heading).

Example: The top down map may show traffic in 360 degree directions around you and could be 25nm ahead of you. However traffic depicted on SVN is limited to 6nm in range and 30 degrees on either side of your aircrafts heading.

Traffic depicted on SVN is similar to the map view, but with only 2 symbol possibilities. Since all traffic shown will be within 6nm, we don't display the diamond with a square inside of it.



Proximity Traffic (within 1200ft relative altitude and less than 6nm range)



Traffic Advisory (within 1200ft relative altitude and less than 0.2nm range)

Obstacle Display

SVN shares the same obstacle database as the top-down map page. Obstacles are shown at their proper height above ground and at their bases are drawn at half of their height.

There are several exclusions users will want to be aware of:

- Obstacles beyond 18nm are not shown
- Obstacles less than 1000ft AGL are not shown beyond 6nm
- Obstacles more than 2,000ft AGL below the aircraft are not shown

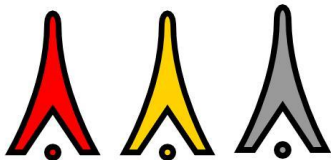

RED: Aircraft is within 100ft AGL of top of tower
YELLOW: Aircraft is within 600ft AGL of top of tower
GRAY: Aircraft is within 2000ft AGL of top of tower.

Highway in the Sky (HITS)



Any EFIS system with Synthetic Vision is capable of displaying Highway in the Sky (HITS). HITS is the artificial generation of boxes that direct the pilot towards a programmed navigation course set by the GPS. HITS is depicted as magenta boxes in the synthetic vision. Waypoint names will also be displayed in the HITS box, giving the pilot further information about their location on the flight plan.

Laterally, the HITS boxes will follow the GPS course programmed by the external GPS navigator or by the internal flight plan. Vertically, HITS boxes are controlled by the altitude bug. If the altitude bug is reset to a higher or lower altitude, ALL of the HITS boxes will move up or down to the altitude. A climbing or descending path will not be displayed.

Enabling HITS

Press [EFIS] -> [AP/FD] -> [HITS ON] or [FD/HITS ON]

Disabling HITS

Press [EFIS] -> [AP/FD] -> [FD/HITS OFF] or [FD ON]

Flying with HITS

Flying with HITS involves positioning the aircraft so the flight path marker (green target) is in the center of the HITS boxes. This will ensure the aircraft actually flies through the center of the boxes. The HITS boxes themselves are 700ft wide by 200ft tall, so there is a very narrow margin to fly through.

Glidepath - HITS will display a glidepath to a chosen runway when setup to do so. To use this feature go to the Flight Plan page (CHECK -> FLT PLAN) and enter a flight plan. Select a runway at the destination, select the glide-angle, enter a crossing restriction and press ACTIVATE. HITS boxes will then be drawn at the prescribed angle up from the runway selected to the altitude entered. For example, a 3 degree angle from RWY 35 at KUAO up to 1,500ft MSL. The highest box will flash white, indicating Top of Decent.

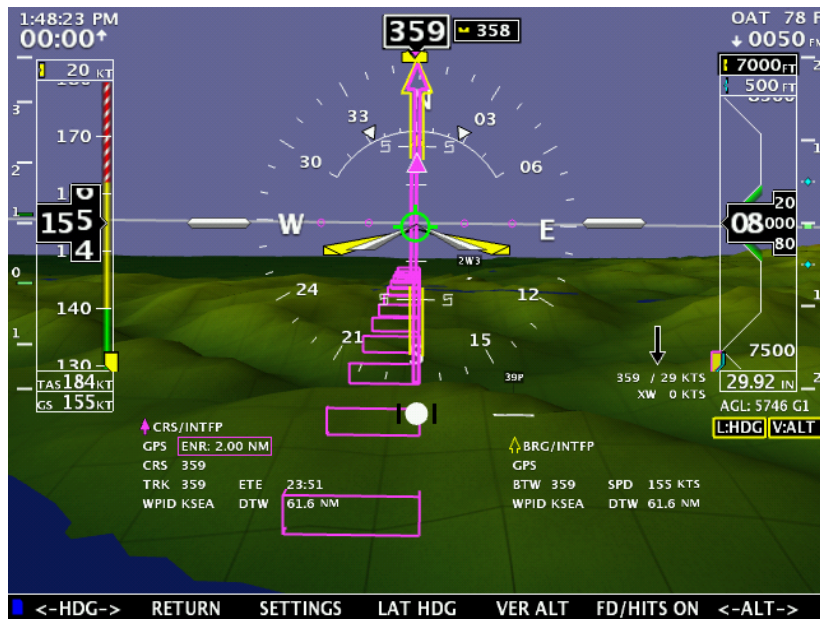

Currently HITS boxes are not drawn for a descent. If the ALT bug is moved to select a lower altitude, the HITS boxes will descend to that altitude, however a vertical descending path will not be drawn. In the screenshot above, the aircraft altitude is 8,000ft, however the ALT bug (and HITS boxes) are drawn at 7,000ft.

EFIS Navigation (HSI)



The EFIS can display an HSI when connected to a Nav radio, GPS, or GPS Navigator. The system has two main navigation needles; Course and Bearing. You can individually select the navigation source for each needle from any radio connected to the unit. If you have an SL-30 connected, you will also get a second bearing needle when the standby Nav frequency is enabled. The source label will indicate the radio type:

Label	Radio Type
NAV1, NAV2	SL-30 Nav/Comm Radio
GNAV1, GNAV2	GPS/NAV/Comm Navigator (430W,530W,480)
GPS1, GPS2	GPS Receiver

The CDI Needle and data is color coded to indicate the source of the data; **Magenta** for GPS data, **Green** for VOR or ILS data.

We currently support data from the following radios:

Radio	Interface	Supported Data
Garmin SL-30	RS-232	VOR, ILS
Garmin 430W/530W/480	RS-232	GPS CDI
	ARINC 429	GPS CDI, LPV, VOR, ILS
Garmin x95/x96 Series	RS-232	GPS CDI
GPS Radio with NMEA-0183	RS-232	GPS CDI

The navigation course and bearing needle sources are selected from the following menu: **[EFIS] -> [NAVIGATION]**

From the navigation menu you can select following sources:

Course CDI needle source:
CRS/NONE, CRS/GPS1, CRS/NAV1, CRS/GNAV1,.....

Bearing needle source:
BRG/NONE, BRG/GPS1, BRG/NAV1, BRG/GNAV1,.....

Note: Selecting CRS/MAP will match the course needle with the navigation source set in the map settings page

GPS Navigation Display

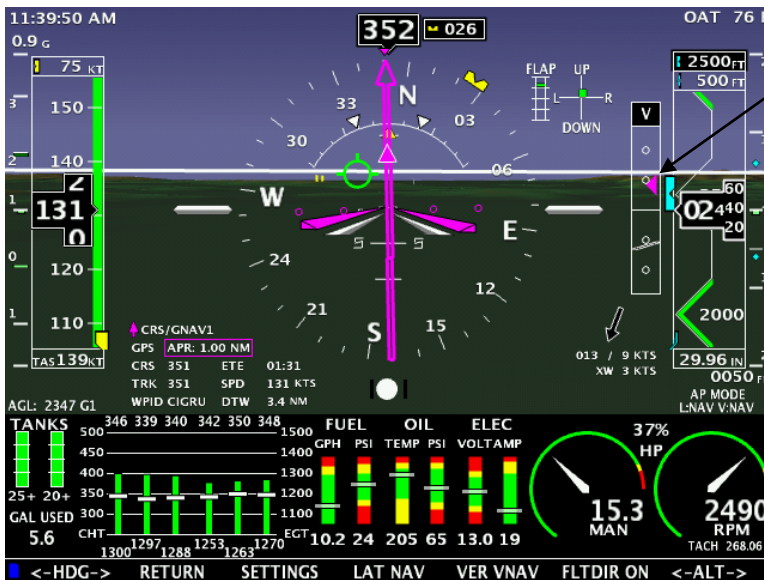

Vertical Deviation Pointer

The Vertical Deviation Pointer (VDP) can be displayed from a WAAS GPS to indicate the baro-VNAV vertical deviation when Vertical Navigation (VNAV) is being used. The VDP should change to a diamond once you are on the approach and receiving glide slope information.

NOTE: Requires a 430W, 530W, or 480 along with the AF-ARINC adaptor module.

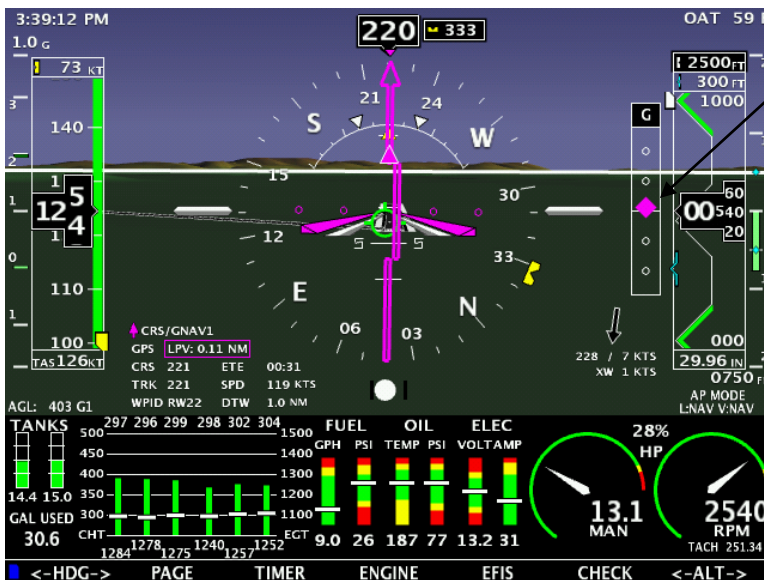

Glide Path Indicator

The Glide Path Indicator (GPI) can be displayed from a WAAS GPS and is analogous to the glideslope for GPS approaches supporting WAAS vertical guidance (LNAV+V, L/VNAV, LPV)

NOTE: Requires a 430W, 530W, or 480 along with the AF-ARINC adaptor module.

CRS (Course)

The Magenta GPS course indicator points to the current course that you have selected on your GPS.

CDI (Course Deviation Indicator)

The GPS CDI scale should be automatically set by the remote WAAS radio using the ARINC data line:

- APR: 0.06 nm / dot
- TRM: 0.2 nm / dot
- ENR: 1.0 nm / dot

TRK (Track)

The current GPS track over the ground is displayed on the HSI by a Magenta triangle. If there is a crosswind it will be different than your magnetic heading.

BTW (Bearing to Active)

BTW displays the direct bearing to the active GPS waypoint and will be displayed on the HSI as a yellow line with two arrows. If you are flying directly to the waypoint on the GPS Course the BTW needle will be under the Magenta needle.

DTW (Distance to Waypoint)

DTW displays the nautical miles to the current GPS waypoint.

SPD (Speed)

SPD displays the current ground speed in nautical miles per hour.

WPID (Waypoint Identifier)

WPID displays the current waypoint ID from the GPS.

VOR Navigation Display

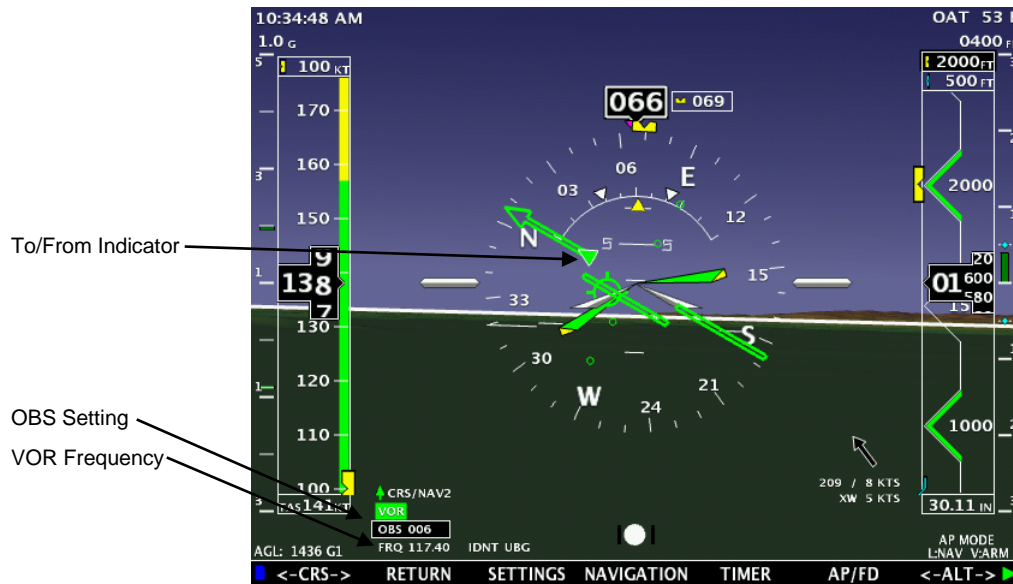

The Green course indicator points to the current course you have selected using the OBS setting. The OBS setting can be set using the knob on the EFIS when <-CRS-> is displayed over the knob (press the knob if **CRS** is not displayed). The current OBS setting is displayed in the text area. If the Nav radio is tuned to a VOR, this is the radial to fly. The SL-30 OBS setting can also be set using the OBS button on the radio. The radio identifier will also be decoded and displayed only if you are using an SL-30 radio.

CDI

Each dot in the course deviation indicator indicates 2 degrees of deviation from the course radial.

VOR

If the radio is tuned to a standard VOR frequency and is giving a valid TO / FROM indication the display will show **VOR** in green letters. If the radio does not have a valid indication the display will show **VOR** and it should not be used for navigation.

BTA

The BTA (Bearing To Active) displays the direct bearing to the active VOR station and will be displayed on the HSI as a yellow bearing needle. If you are flying directly to the VOR on the Course OBS setting the bearing needle will be under the Green course needle.

BTS

The BTS (Bearing To Standby) displays the direct bearing to the Standby VOR station if you have selected M (monitor) on the SL-30. The BTS will be displayed on the HSI as an orange line with a circle.

IDNT

IDNT displays the current nav frequency identifier decoded from the SL-30.

TO/FROM

The To/From radio flag will be displayed by a green triangle on the course needle.



ILS Navigation Display

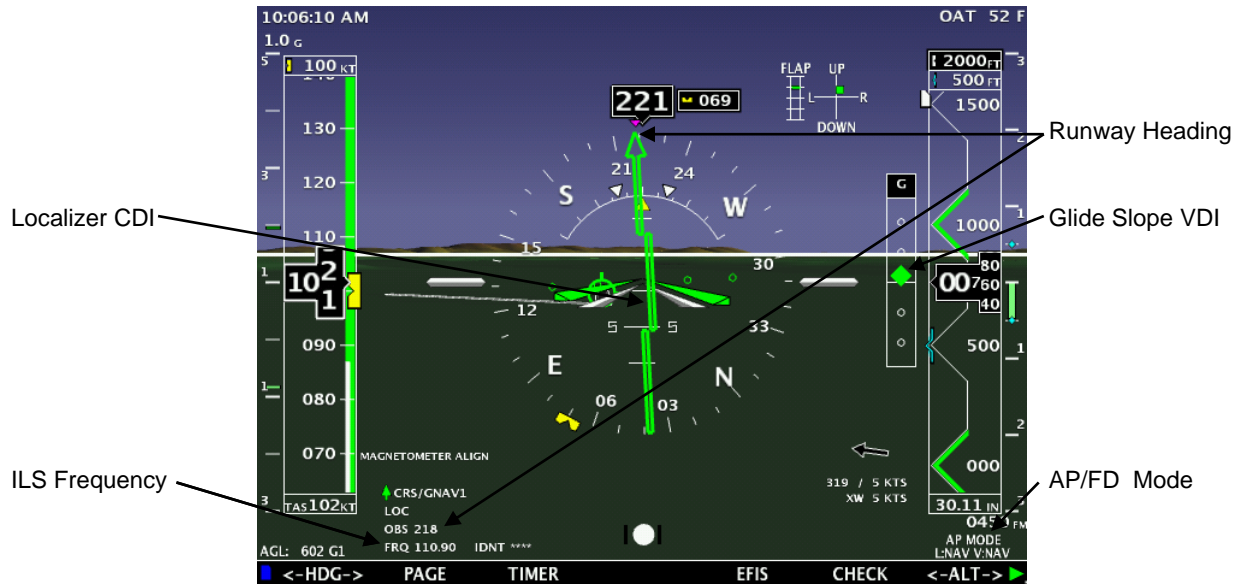

You should always set the ILS inbound Approach Course using the CRS knob selection.

If the Nav Radio is tuned to an ILS frequency you should use the CRS setting to select the **inbound approach course**.

NOTE: The SL-30 will not let you adjust the OBS if you have selected an ILS freq and you must use the CRS knob on the EFIS to set the course indicator.

The course indicator is fixed to the rotation of the DG. The Green course indicator will only be displayed if you are tuned to a VOR or a localizer.

LOC

If the radio is tuned to a standard ILS frequency and is giving a valid indication the display will show **LOC** in green letters. If the radio does not have a valid localizer indication the display will show **LOC** in red and it should not be used for navigation.

GS

If the nav radio has a valid glide slope indication the display will show **GS** in green letters. If the radio does not have a valid glide slope flag it will display **GS** in red and it should not be used for navigation.

BC

If the nav radio is tuned to a localizer and is in back course mode **BC** will be displayed in green.

NOTE on Back-Course: If you are flying a back-course with an HSI and the SL-30 is NOT in back-course mode, you should set the course selector "OBS" to the front course heading so no reversal will be needed since the CDI indicator spins with the DG. If you have the SL-30 in back-course mode, you must set the course selector to the heading of the back-course runway or the CDI needle will be reversed.

Internal Flight Planning

(Requires Version 8 software or later)



AF-3000s/4000s series displays have an internal flight planning feature, eliminating the requirement for an external GPS to provide flight plan waypoints. Only a basic GPS with NMEA data output is required to utilize this feature (though it can still be used with any GPS navigator as well). If you have another GPS navigator with flight planning capability, it will transfer the flight plan to the EFIS internal flight plan.

Accessing the Flight Plan page

Press [CHECK] -> [FLT PLAN]

Information Displayed:

DTK: Desired Track to Waypoint

VSR: Vertical Speed Required

DTW: Distance to Waypoint

WPID: Waypoint Identifier

RW: Runway: (Number) > (Glide Angle)

ETE: Estimated time Enroute (leg)

Cross xx Before: Distance from waypoint to cross at

AT/ABOVE/BELOW xxx: Cross the prescribed distance from the waypoint at/above/below the set altitude

[SRCSEL] - Selects the GPS source for the internal flight plan (GNAV 1 / GNAV 2 / GPS1 / GPS 2)

[CHART] - Displays the approach plate (if installed on the SD Card) for the destination airport

Creating a Flight Plan

There are two ways to program a flight plan; manually or automatically transfer through another GPS.

To manually create a flight plan, follow these simple steps:

Go to the FLT PLAN page [CHECK] -> [FLT PLAN]

Press EDIT

Press INSERT

A waypoint box will appear with the cursor, allowing a waypoint to be entered

Once the waypoint has been entered, press in the right knob to deselect cursor mode

To add another waypoint, press EDIT -> INSERT and follow the same steps as above

To remove a waypoint in the flight plan, press [EDIT] and use the cursor to highlight the waypoint, press [REMOVE]

Activating the Flight Plan

After the flight plan has been created, pressing the ACTIVATE button will change the EFIS navigation source to follow the internal flight plan.

Direct-To

Proceeding Direct-To an intermediate waypoint: Use the cursor to highlight the waypoint to proceed to, press the [D-To] button. The EFIS will then sequence to the selected waypoint.

Fly-Leg

The Fly-Leg features is used to fly a leg between two intermediate waypoints. For example, a flight plan has A, B, C, and D intersections before the destination and you want to skip A and fly the leg between B and C (an airway). Use the cursor to highlight the second of the two legs and press [FLY LEG].

Suspending a Flight Plan

The [SUSPEND] button will freeze the current flight plan and cause the HDG and ALT bugs to sync to the current heading and altitude. It will also change the AP/FD mode to LAT: HDG VER: ALT, meaning the autopilot will take-over and hold the current heading and altitude. This is useful when ATC gives an amended clearance and you need time to modify the flight plan.

Vertical Navigation using the internal Flight Plan

Using the internal flight plan, the EFIS can descend to preset altitudes at each waypoint. For example, if the aircraft is at 10,000ft (set by the ALT BUG), a user can program 8,000ft for the first waypoint, 6,000ft for the second waypoint, 3,000ft for the third waypoint..etc. To enter a crossing altitude, edit a waypoint and enter a distance from the waypoint to cross at and an altitude. Perform this procedure for all waypoints a crossing altitude is desired and press [ACTIVATE].

Note: If no crossing altitudes are entered, the EFIS will follow the ALT bug.



Autopilot Control / Flight Director

Note: There is a separate AF-Pilot Installation Manual found on the AFS website.

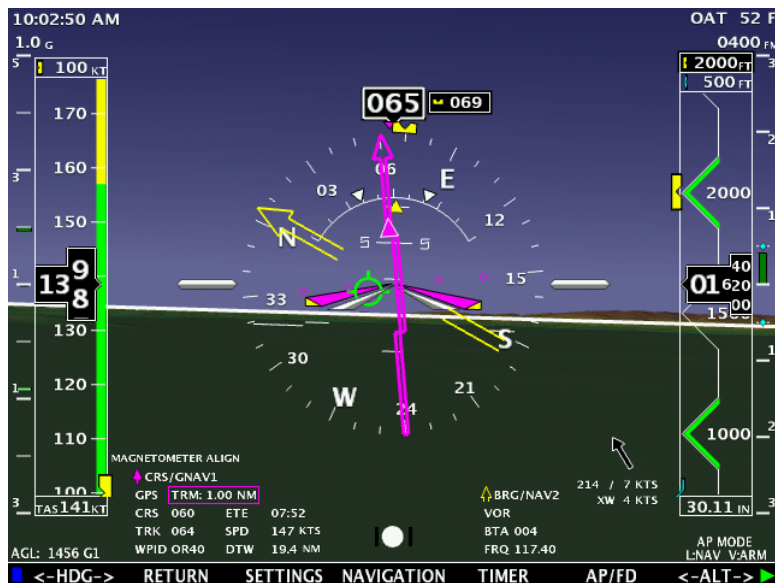

Current AP Mode

Autopilot Control

For the autopilot to follow the EFIS commands you will need an autopilot that is capable of GPSS and GPSV ARINC steering commands. You will also need to have the optional AF-ARINC module connected to the EFIS and properly configured.

The following Autopilots will work with the EFIS:

ADVANCED Pilot
 TruTrak DigiFlight II VSGV
 TruTrak Sorcerer
 Trio Pro Pilot

The autopilot and flight director are very closely connected and are controlled from the same source. If your aircraft has our **ADVANCED Pilot** autopilot it supports GPSS (GPS steering) and GPSV (GPS vertical steering) and the aircraft should closely follow the flight director when the autopilot is in EFIS Mode.

ADVANCED Pilot Autopilot Controls

The AF-Pilot Autopilot is manufactured by TruTrak, it is very similar to the DigiFlight II VSGV and has all of the same wiring, configuration, and setup. You must have the Primary Serial Input Pin on the AP connected to your GPS along with the ARINC A and B lines connected to the AF-ARINC module. The autopilot should be installed in accordance with the AF-Pilot Installation Manual.

Your AF-Pilot or DigiFlight II Autopilot must have the latest software that accepts vertical speed commands.

Compatible Software - DigiFlight Series: 2.32 - 2.36, 2.38, 2.39, 2.41 and later
 Sorcerer: 2.38, 2.41, and later

The AF-Pilot has the following modes controlled from the buttons on the face of the autopilot.

[AP] - Autopilot control mode. Pressing the AP button will cause the autopilot to turn on and follow the current ground track and the current vertical speed of the aircraft. The EFIS settings and controls will not have any effect on the autopilot. Once the autopilot is controlling the aircraft, pressing the knob button will select the Track or Vertical Speed fields. Once the cursor is on the desired field you use the knob to adjust either the desired track or the desired vertical speed. The Autopilot can be turned off at any time

by pressing the [AP] button or external button if you have one connected to the control wheel steering input line of the autopilot.

[EFIS] - EFIS control mode. Pressing the EFIS button will cause the autopilot to turn on and follow the current AP/FD settings from the EFIS. The Autopilot can be turned off at any time by pressing the [AP] button or external button if you have one connected to the control wheel steering input line of the autopilot.

EFIS Flight Director/Autopilot

Turning on the AP/FD Mode

The flight director can be turned on from the following menu: [EFIS] -> [AP/FD] -> [FLTDIR ON/OFF]

The wings that come up when the flight director is enabled will show the aircraft positioning to follow. All the pilot has to do is keep the triangle in the wings as they move to follow the commanded source. A change in heading or track will command the wings to bank in the direction to acquire the new heading or track. A command to climb or descend to a new altitude will cause the wings to move up or down.

The Flight Director Wings are color coded based on the command source. The wing bar color will show the horizontal steering source and the triangle tip color shows the vertical steering source.

Gray	No Source
Red	Source Flagged
Yellow	Heading / Altitude Bug
Magenta	GPS
Green	VOR / ILS



Autopilot and Flight Director controlled by Heading and Altitude Bugs

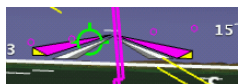

Horizontal = GPS and Vertical = Altitude Bug



Autopilot and Flight Director controlled by CDI source = GPS



Autopilot and Flight Director controlled by CDI source = NAV (VOR or ILS)



Vertical = Minimums Bug

The Autopilot and Flight Director will level the aircraft at the Minimums Bug and not fly below it. 200 feet above the Minimums Bug the FD tips will turn Orange and you will get a MINIMUMS warning on the EFIS screen.

If you are having difficulty getting the AP/FD to descend on an ILS or LPV check your MINS Bug altitude!



CDI source is flagged as bad; Vertical = Altitude Bug



No Horizontal Nav source; Vertical = Altitude Bug

Autopilot / Flight Director Control Settings

LATERAL EFIS Autopilot Control Settings

Roll GAIN .05 Range (.01 – 2.0)

The LAT Gain setting controls how fast the aircraft will respond to errors in track or heading. With too low of a setting the aircraft will hunt slowly and appear slow to respond in roll. With too high of a setting the aircraft will hunt rapidly, and appear jittery.

Loc GAIN .50 Range (.1 – 3.0)

The Loc Gain setting controls how fast the aircraft will respond to errors in tracking the Localizer. With too low of a setting the aircraft will hunt slowly and appear slow to respond in roll. With too high of a setting the aircraft will hunt rapidly, and appear jittery.

VERTICAL EFIS Autopilot Control Settings

Alt Gain 5.0 Range (.1 – 12.0)

Controls how fast the aircraft will respond to errors in altitude. With too low of a setting the aircraft will hunt slowly and appear slow to respond in altitude. With too high of a setting the aircraft will hunt rapidly, overshoot the altitude, and appear jittery.

GS GAIN 3.0 Range (.1 – 10.0)

The Glide Slope gain controls how fast the aircraft will respond to altitude errors on the ILS glide slope. With too low of a setting the aircraft will hunt slowly and appear slow to respond in altitude. With too high of a setting the aircraft will hunt rapidly, overshoot the altitude, and appear jittery.

FD GAIN 1.5 Range (.1 – 10.0)

The Flight Director gain controls how fast the Flight Director responds to errors in pitch.

MIN SPD 75 Range (Vs0 - Vne)

The minimum speed that the EFIS will try to command the Autopilot to fly.

MAX SPD 165 Range (Vs0 - Vne)

The maximum speed that the EFIS will try to command the Autopilot to fly.

<-VSPD-> 500 FPM Range (0 – 2000FPM)

The vertical climb speed that the aircraft will use to change altitudes can be selected from the <-VSPD-> knob selection. The current setting is shown on the vertical speed tape as two small Cyan triangles. If the current setting will cause the aircraft to fly below the MIN SPD in climb the triangles will adjust the vertical speed so that the MIN airspeed is maintained. If the vertical climb speed is being limited by the Minimum airspeed setting the triangle will change color to orange.



AP/FD Lateral Modes

LAT HDG Aircraft will follow the Yellow heading bug on the HSI

LAT NAV Aircraft will usually follow the current CDI needle on the HSI. If the EFIS is detecting valid GPSS commands from the currently selected Nav source those commands will be used for the autopilot control. This will enable the autopilot to follow the turn anticipation and holds from a GPS navigator.

LAT ARM Localizer
 Aircraft will follow the heading bug on the HSI until the **CDI needle deflection is less than 80% AND the Current aircraft heading is within 30 degrees of the CDI course.**
 The AP/FD status on the EFIS will show ARM unit switching to NAV mode.
GPS

Aircraft will follow the heading bug on the HSI until the **CDI needle deflection is less than 80% AND the Current aircraft heading is within 90 degrees of the CDI course.** The AP/FD status on the EFIS will show ARM unit switching to NAV mode.

LAT OFF Any GPSS steering commands from the navigation radio will be passed through to the Autopilot in the AF-ARINC module.

As long as the aircraft has enough of a turn and the LAT Gain is high enough, the aircraft should try and use a standard rate turn for the bank angle.

AP/FD Vertical Modes

VER ALT Aircraft will follow the Yellow Altitude bug on the altimeter tape.

VER ARM Aircraft will follow the Altitude bug until the CDI & GS needle deflection is less than 80%, once this occurs the Aircraft will follow the vertical NAV source. **If the vertical GS needle is lost in ARM or NAV mode the Autopilot and Flight director will switch back to following the altitude bug after 5 seconds.** This enables vertical guidance to the altitude bug on a missed approach.

VER OFF Any GPSV steering commands from the navigation radio will be passed through to the Autopilot in the AF-ARINC module.

VER FPL Aircraft will follow the internal flight plan vertical navigation crossing altitudes and will descend per the flight plan if a glide-angle is setup and vertical navigation is enabled.

Changing Autopilot Mode

You can change autopilot modes by pressing EFIS -> AP/FD and then the LAT or VER button. The joystick on the AF-4500 can also be used as a shortcut. LEFT and RIGHT cycle between Lateral modes while UP and DOWN cycle through Vertical modes. Moving the joystick to the left for about 1.5 sec, for example, will prompt the user "AUTOPILOT MODE L:HDG?". Press the joystick in to Confirm.

AF-4500 Joystick

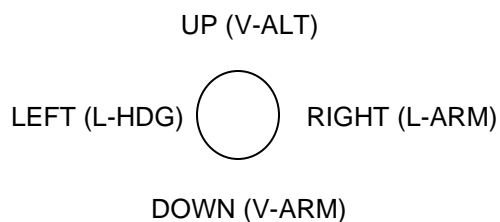

Autopilot / Flight director in ARM mode.



AP MODE

The AP/FD is currently tracking the Heading and Altitude Bugs. The AP/FD Mode text shows **L-ARM** and **V-ALT**, the Flight director wings are yellow indicating that it is being controlled from the Bugs



As soon as the green VOR CDI needle moves to within 80% and the heading is within 30 degrees of the CDI course, the FD wings will change to green and the status will change to **L-NAV**.

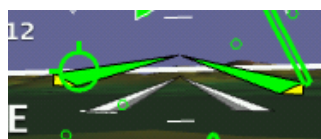

The FD wingtip color indicates the current vertical source. In this picture the FD wings are green indicating that the lateral mode is being controlled by the NAV radio, the tips are yellow indicating that the vertical mode is from the altitude bug.

For the autopilot to follow the EFIS commands it will need to be in GPSS and GPSV mode.

ADVANCED Pilot Settings

The following settings are a good starting point for the **ADVANCED** Pilot autopilot

Lat Activity	5	Vert Activity	4
Lat Torque	12	Vert Torque	12
Bank Angle	High	Static Lag	2
Microactivity	0	Microactivity	0
GPSS Gain	16	Half Step	N

For more detailed settings for an RV-10, RV-4, and Sportsman See *Appendix J*.

The ABOUT Page

[CHECK] -> [MAINT] -> [ABOUT]

This page contains a lot very important information about your system.

System Info contains your system Serial Number. This is very important to have when you call AFS for technical support.

Next is your software version information, IP address, and installed keys.

MAP: Mapping
AOA: Angle of Attack
SVT: Synthetic Vision

Mapping Status gives you the version of mapping software, region, map effective and expiration dates, and status of the map Vector and Terrain file.

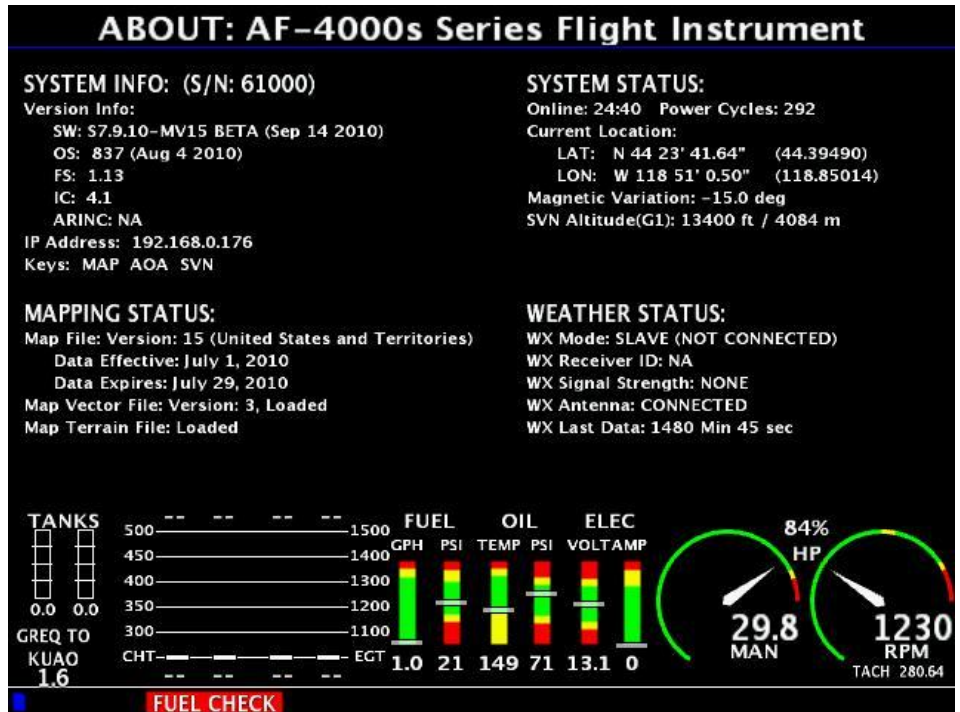

System Status contains information related to how long your system has been powered-on for, how many power cycles the unit has had over its life, your current GPS LAT/LON position, current magnetic variation (received from the GPS), and the current synthetic vision altitude above the ground.

Weather Status shows information for diagnosing XM or ADS-B Weather module problems.

Mode: Shows the mode of that particular screen (MASTER or SLAVE).

Receiver ID: Shows the unique identification number of your receiver

Signal Strength: Indicates the current strength of the XM satellite signal (NONE, POOR, AVERAGE, GOOD)

Antenna: Indicates whether or not an XM antenna is connected

Last Data: The elapsed time from the point of the last weather data received.

Note: Weather Status will not be shown if WX is set as OFFLINE in Instrument Calibration.

Moving Map Display

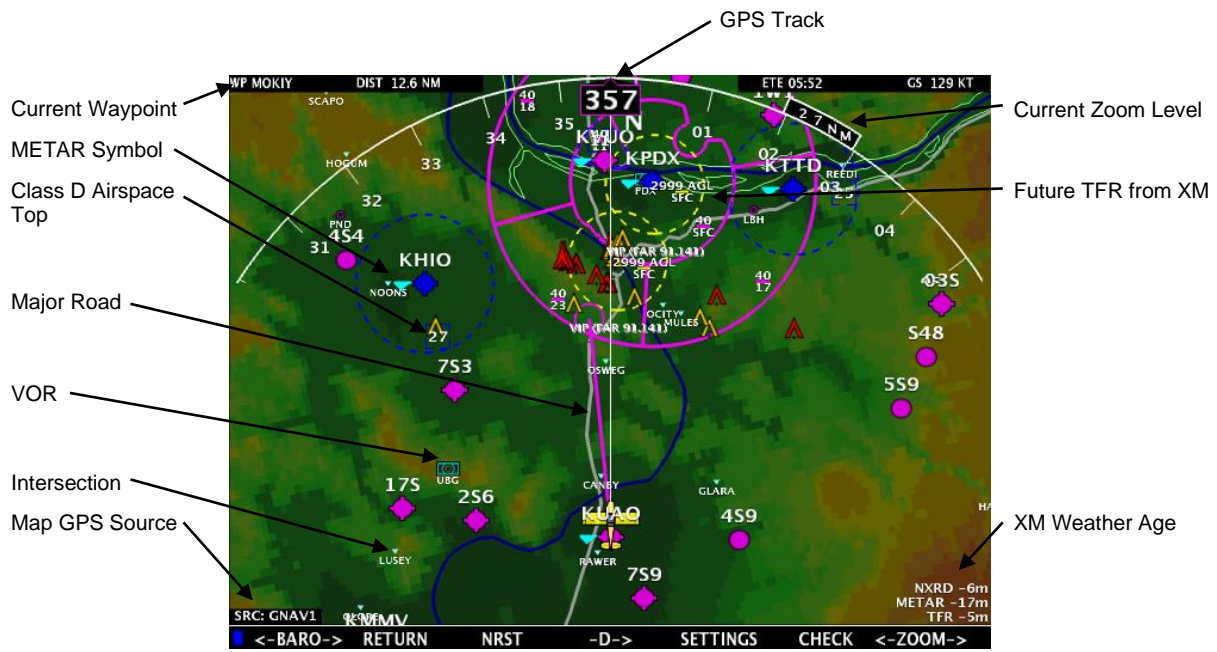

The system can display a moving map if you have purchased and installed the optional Mapping package. You will need to have the SD card installed with the mapping database for proper operation.



WARNING: The moving map is to be used as a reference only and is not to be used in place of current aviation charts or for primary navigation.

Map Features

Currently the map will display the following features for the United States Only:

- | | |
|--------------------------------|----------------|
| 1. Public and Private airports | 5. State Lines |
| 2. Airspace | 6. Rivers |
| 3. Intersections, VOR's | 7. Major Roads |
| 4. Obstructions | 8. Cities |

The moving map can be displayed as a partial screen along with the EFIS and/or Engine Monitor or as a complete page. You can also select if the airspeed and altitude tapes and engine monitor are displayed on the map from the [MAP] -> [SETTINGS] menu and selecting the [AIR OFF] [Engine] buttons.



EFIS-Engine-Map Page

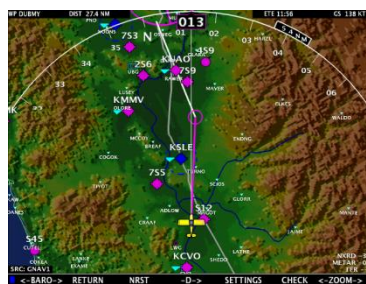

Map Page Air & EMS OFF



Map Page with Air ON EMS ON

Map Data Source

The current flight plan source that is displayed on the Map can be set from the following menu:

[MAP] -> **[SETTINGS]** -> **[SRC/???**] where SRC/??? Can have the following options depending on the radios installed in the aircraft:

SRC/GNAV1 430W/530W/480 GPS Navigator Radio setup as GPS 1

SRC/GPS2 External GPS unit setup as GPS 2

SRC/MAP Flight Plan activated from the EFIS Map

Private Airports

The **[MAP]** -> **[SETTINGS]** -> **[MORE]** -> **[PVT ON/OFF]** button gives you the option of displaying or not displaying private airports on the moving map screen.

Intersections

The **[MAP]** -> **[SETTINGS]** -> **[MORE]** -> **[INTS ON/OFF]** button gives you the option of displaying or not displaying Intersections on the moving map screen.

Zoom Range

The current zoom range is displayed by an arc on the top of the map display with its current digital range. The zoom range can be adjusted using the knob anytime **[ZOOM]** is displayed. The map software will progressively declutter airports, intersections and obstacles from the screen as you zoom out farther.

Nearest Airport

Pressing the **[NRST]** button from the map menu will bring up a sorted list of the nearest eight airports displayed on the screen at the current zoom level. If you want to see the actual closest airports you should zoom in before pressing the **[NRST]** button. You can then use the knob so select the desired airport. Pressing the **[INFO]** button will display the information for the highlighted airport.

CAUTION *If you want to see the actual closest airports you should zoom in before pressing the **[NRST]** button.*

Direct To Navigation

Pressing the **[-D->]** button from the map menu will enable you to select the desired airport to navigate to by using the knob.

Airport Info

Pressing the **[INFO]** button from the map menu will bring up multiple pages of airport info, including runways, frequencies and airport information.

Airspace

Airspace is displayed on the moving map along with its vertical boundaries in a similar format to a sectional chart.

Track Mode

The desired map track mode can be selected from the **[MAP]** -> **[SETTINGS]** menu and selecting either **[TRACK UP]** or **[NORTH UP]**

Map Database Files

The moving map uses the following database files stored on the SD card, the SD card must be kept in the EFIS for the map to work. :



AFS USA Data Files

AF-3400 & AF-3500 non “S” CPU (OLD Systems)

File Name	Description	Update Frequency
AFSTERUS.AFM	Terrain height information for the US	When Required
AFSVECUS.AFM	Vector data for US roads/rivers/lakes/cities	When Required
AFSMAPUS.AFM	Navigational data (airports, obstacles, nav aids, ...)	Every 28 Days

AF-3400s, AF-3500s, AF-4500s “S” CPU (New Current Systems)

File Name	Description	Update Frequency
AF2TERUS.AFM	Terrain height information for the US	When Required
AF2VECUS.AFM	Vector data for US roads/rivers/lakes/cities	When Required
AF2MAPUS.AFM	Navigational data (airports, obstacles, nav aids, ...)	Every 28 Days

Worldwide Jeppesen Data Files

The Terrain and Vector files are provided by Advanced Flight Systems and are rarely updated. The MAP files are provided by Jeppesen and install on the SD card using their JSUM program.

AF-3400 & AF-3500 non “S” CPU (older systems)

File Name	Description	Source
AFSTERxx.AFM	Terrain height information for the US	AFS Web Store
AFSVECWW.AFM	Vector data for US roads/rivers/lakes/cities	AFS Web Store
AFSMAPxx.AFM	Navigational data (airports, obstacles, nav aids, ...)	Jeppesen JSUM

AF-3400s, AF-3500s, AF-4500s, AF-5000 (New Current Systems)

File Name	Description	Source
AF2TERxx.AFM	Terrain height information for the US	AFS Web Store
AF2VECxx.AFM	Vector data for US roads/rivers/lakes/cities	AFS Web Store
AFSMAPxx.AFM	Navigational data (airports, obstacles, nav aids, ...)	Jeppesen JSUM

xx Region Code for your area.

AF	Africa
AS	Asia
EU	Europe
ME	Middle East
NA	North America
SA	South America
PA	Pacific

AFSMAPUS.AFM and AFSVECUS.AFM files have a version number associated with them, and will only work with a version of the system software that is compatible. When you download the map files, make sure that your version of the system software matches the map version. If it doesn't match, the map will not work.

Example:

AF3000 Series System Software Version 7.7.15-MV15 <-The MV15 is the map version

Map Data files Version MV15

Map Database Update Procedure

1. Format SD Card

Format the SD card on your PC for "FAT32". Right click your SD drive icon and click on format. You should also make sure it is set for FAT32.

2. Download current Map database files

Go to our website under the Downloads header -> Map Data.

www.Advanced-Flight-Systems.com

Right click the zip file and select **Save Target As**, select your desktop as the target location and click **Save**. Once the file has been downloaded, extract the 3 files within the zip file to your freshly formatted SD Card. Once you are finished you should have the following three files on your SD card:

- AFxMAPxx.AFM Airport and Airspace data
- AFxTERxx.AFM Terrain data
- AFxVECxx.AFM Roads, Rivers, Lakes and Cities

3. Install SD Card into EFIS

4. Verify the Effective and Expiration Dates are correct on the / Agree screen

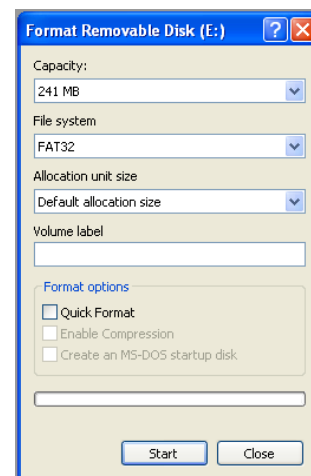

Traffic Display



WARNING: Traffic information displayed on the Map is provided for visually assisting in acquiring other aircraft. The aircraft should be maneuvered based only upon ATC guidance or positive visual acquisition of conflicting aircraft.

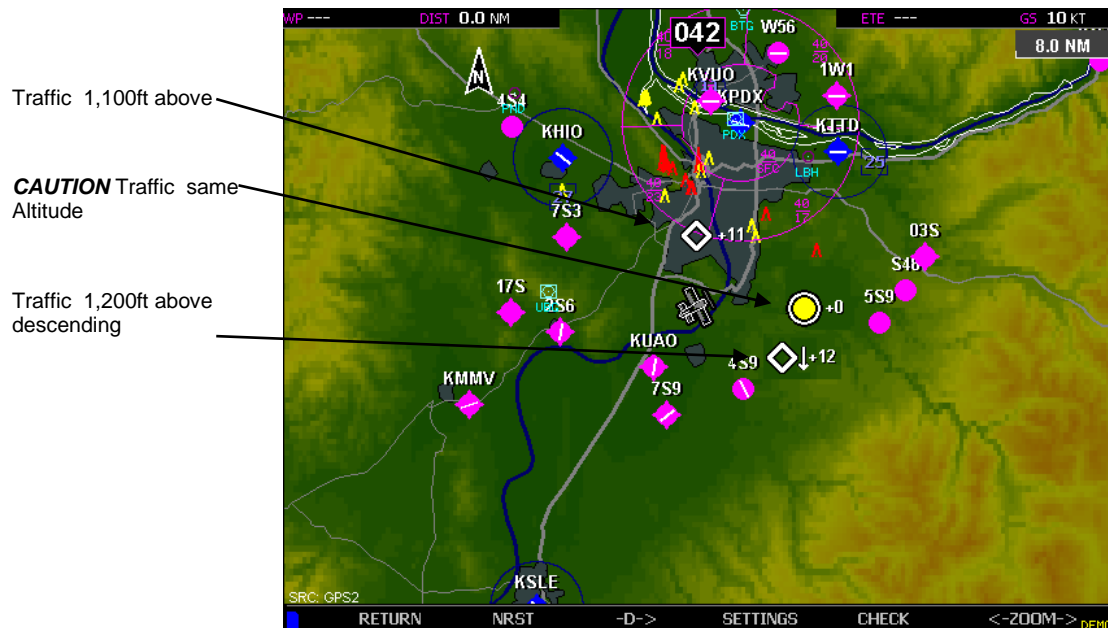

The AFS-Map can display traffic when connected to a NavWorx ADS600-B, Garmin GTX-330, or Zaon XRX.

Traffic Display on the Map

Traffic is displayed using the standard TCAS-II symbology



Other Traffic (Greater than 7000ft relative altitude and greater than 7nm range)



Proximity Traffic (within 1200ft relative altitude and less than 6nm range)



Traffic Advisory (within 1200ft relative altitude and less than 0.2nm range)

Zaon XRX

XRX detects up to three threat aircraft from within your cockpit using a cutting-edge, proprietary, self-contained antenna design. With direction, locating and identifying traffic is simple and easy, and traffic information is displayed on the EFIS Map page. XRX delivers the three "dimensions" of traffic information that pinpoints where traffic is located: direction, range and relative altitude. Traffic accuracy is 0.2 NM on average for range, ± 200 ft for altitude (defined by TSO standards set for transponder encoders), and $\pm 22^\circ$ for direction. For detailed Zaon information and capabilities: www.zaon.aero

Zaon EFIS Setup

After connecting the Zaon XRX to EFIS serial port #2 you will need to configure the serial port in the EFIS for ICARUS/TRFC. You will also need to configure the Zaon output to Garmin Traffic mode.

Garmin GTX-330

The IFR-certified GTX 330 offers a Traffic Information Services (TIS) interface, giving you greater traffic awareness in some of the United States's busiest airports. TIS traffic from the GTX330 is displayed on the map, including location, direction, altitude and climb/descent information for nearby aircraft.



GTX-330 EFIS Setup (hold FUNC + ON keys)

After connecting the GTX 330 Serial port #1 to EFIS serial port #2 you will need to configure the serial port #2 for ICARUS/TRFC

<u>EFIS Main Harness</u>	<u>GTX-330</u>	<u>EFIS Configuration</u>	<u>GTX330 Configuration</u>
13	22	ICARUS/TRFC	ICARUS ALT
25	23	ICARUS/TRFC	REMOTE + TIS

NavWorx ADS-B

ADS-B is only compatible with s-CPU units.

The NavWorx ADS600 series ADS-B equipment can be directly interfaced to your EFIS. The ADS600 UAT receiver displays ADS-B information including TIS-B traffic and FIS-B weather. The ADS600-B UAT Transceiver displays the same information but also transmits your position to the ADS-B system. ADS-B is a free service provided by the FAA that transmits weather and traffic information to aircraft with compatible receivers. With a transceiver, aircraft can participate in the system by transmitting their position to the ADS-B system for the benefit of other aircraft and ATC.

ADS600 (-B) Setup

Connect the NAVWORX device to your EFIS in accordance with the NavWorx installation manual. The ADS600-B Display Port can connect to any available AFS serial port. The ADS600-B Altitude Encoder Port should connect to AFS serial port #2. It is **important** to have the NavWorx maintenance port connected to a DB9 connector. This will allow for future software updates and to setup/configure the ADS-B box.

Configure Serial Port #3 for ADSB115K and Serial Port #2 for TFC/ICARUS

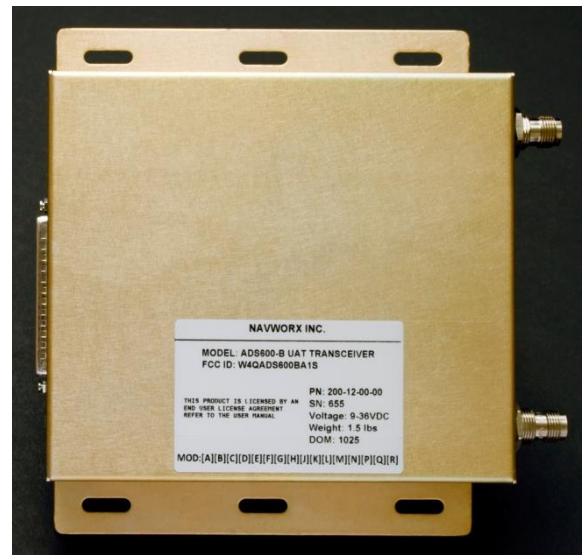

<u>EFIS Main Harness</u>	<u>ADS600(-B) P1</u>	<u>EFIS Configuration</u>
--------------------------	----------------------	---------------------------

13	Serial #2 TX	7	ICARUS/TRFC
5	Serial #3 RX	5	ADS-B
4	Serial #3 TX	24	ADS-B
21	Serial #3 GND	23	ADS-B

Use the NavWorx manual to connect to its maintenance port. The following **three commands must be entered** into the NavWorx box: 1. SET PROTOCOL TA, 2. MAP TA RS232, 3. SET BAUD 115200.

To prevent seeing yourself called out as traffic (ghosting), connect one of the Serial outputs of the GTX-330 configured as REMOTE + TIS to Pin 33 of the ADS600-B box. Send the following command to the ADS600-B. TXCP GTX330 or TXCP GTX327.

uAvionics Echo

ADS-B is only compatible with s-CPU units.

The uAvionics echo ADS-B receiver sends ADS-B information including TIS-B traffic and FIS-B weather to the AF-4500 or AF-3500s. The UAvionics Echo sends the ADS-B data in GDL90 format at 115.2 kb. The Echo must be wired to EFIS high speed serial ports #1 or #3. The EFIS serial port should be configured as *ADSB 115 K*

You should check with Uavionics for the Echo Com 2 GPS requirements.



EFIS Main Harness	Echo Pin	Description	Function
	1	Ground	
	2	Power	
5 Serial #3 RX	3	Com 1 RS-232 TX	ADSB Data
4 Serial #3 TX	4	Com 1 RS-232 RX	
	5	Com 2 RS-232 TX	
	6	Com 2 RS-232 RD	GPS Data

73,102 Dynon SV-GPS-250 Connections

AF-4500 Connecting Dynon SV-GPS-250 AFS P/N: 73102

Change EFIS Serial Port #4 Setting to 73,102 AF-GPS

The GPS module uses the same power pin as the OAT probe

73102 GPS	GPS Description	EFIS Connection	PIN	EFIS Description
ORANGE	Power	EFIS MAIN	6	OAT Power
BLACK	Ground	EFIS Expansion	2	GPS Ground
PURPLE/GRAY	GPS TXD	EFIS Expansion	6	RS-232_RXD
ORANGE/GRAY	GPS RXD	EFIS Expansion	1	RS-232_TXD

EFIS Main Cable



EFIS Expansion Cable



Garmin GTS-8xx TCAS System

The Garmin GTS-8xx TCAS System is a fully self-contained active traffic system which will interface to your EFIS display. Please see the Traffic ARINC Adapter Wiring Diagram for wiring and configuration.

ARINC output speed on the GTS-8xx MUST be configured for LOW speed!

Note: A special TCAS ARINC adapter is required; please contact AFS for more information.

Weather Display



CAUTION: NEXRAD weather data should only be used for long-range planning purposes. Inherent delays and relative age of the WX data can be experienced. NEXRAD weather cannot be used for short-term weather avoidance.

NEXRAD

High resolution radar image of radar reflectivity and lightning strikes.

Reflectivity is the amount of transmitted power returned to the radar receiver. The NEXRAD colors directly correlate to the level of detected reflectivity from the radar.

To enable/disable NEXRAD press [MAP] -> [WX] -> [NXRD ON/OFF]

LIGHT

HEAVY

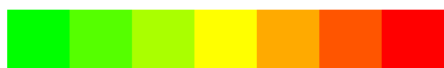

NEXRAD DATA AGE

The current age of the NEXRAD data is shown in the lower right hand corner of the map, 4 minutes old in this example.

NEXRAD LIMITATIONS

- NEXRAD base reflectivity does not provide sufficient information to determine cloud layers or precipitation characteristics. You cannot distinguish between wet snow, wet hail, and rain.
- NEXRAD base reflectivity is sampled at the minimum antenna elevation angle. An individual NEXRAD site cannot depict high altitude storms at close ranges. It has no information about storms directly over the radar site.

- When zoomed in a square block on the display represents an area of 2 ½ miles. The intensity level reflected by each square represents the highest level of NEXRAD data sampled within the area.

METARS

Airports with METAR data are displayed with a colored flag next to the airport symbol on the map.

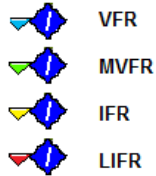

If an airport has METAR data a weather page will be added to the airport info after the frequency page, usually page 2.



TAF's

Airports with TAF's will have a special "T" symbol next to the airport on the map page. In addition, there will be a TAF button on the airports info page. TAF's are given in their original coding.

TFR's

Active TFR's are drawn in RED and future TFR's are YELLOW. Your screen will remember the last TFR's displayed upon shut-down so those that remain active are displayed at the next power-up (before XM WX comes online). This is done by saving all TFR's onto the SD Card as a file named "TFR.xml". If a TFR becomes inactive before the next power-cycle, that TFR will not be displayed. Similarly, if a future TFR becomes active before the next power-cycle, that TFR will be displayed.

Lightning

Lightning is displayed as lightning bolts as part of the NEXRAD weather display.

To enable/disable Lightning press **[MAP] -> [WX] -> [LGHT ON/OFF]**

Winds Aloft

Winds aloft are displayed over the map page using standard NOAA barbed symbols. To change the altitude, use the right knob to select WNDS as the function. Altitudes are given in Flight Levels (i.e. FL120 is 12,000ft)

To enable/disable Winds Aloft press **[MAP] -> [WX] -> [WNDS ON/OFF]**

XM Weather

Weather Module installation

The WxWorks XM Weather Module should be mounted on the inside of the aircraft and the antenna located on the aircraft glare shield. The XM Weather module should be powered from a 12V aircraft source. The weather receiver communicates with the EFIS screens using the Ethernet port. For a dual screen installation you will need to use a separate Ethernet hub in the aircraft. If you have a single screen system you can plug the weather receivers Ethernet cable directly into the EFIS.

Screen Configuration Settings

One of the screens in the aircraft needs to be configured as the Weather Master and any additional screens should be set to Slave or Offline.



Currently we do not support weather on both the new “s” CPU along with the older non “s” CPU on the same network. You should pick one system to make the master and configure the other system as Offline.

The screen with the Engine Monitor connections should be configured as the Weather Master in the ADMIN settings menu of calibration.

- 1. Admin Settings
- 18. WX Module Config MASTER

Any additional screens should be configured as a Weather SLAVE in the ADMIN settings menu of calibration.

- 1. Admin Settings
- 18. WX Module Config SLAVE

Network Ethernet hub

We recommend a Linksys 5-Port 10/100 Switch Model SE2500, this is a 12V powered unit.

XM Weather Service

After the installation is complete and you are able to move the aircraft outside so that the Antenna can receive the Satellite signal you will need to call XM to subscribe to a service plan. Currently the AFS software will display the following items from the “Aviator LT” XM WX Data Packages: **NEXRAD, TFR's, METAR's, TAF's, and Lighting.**

Note: Non-s CPU units cannot display TAF's due to hardware limitations.

You will need your radio ID Number from the receiver when calling XM at the following number:

XM Activation 1-800-985-9200

XM Diagnostics

The XM status message and logo will indicated the current XM receiver status using the following messages:



Screen is searching for weather receiver.

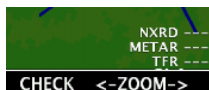

Screen is waiting for the XM data for the first time since turning on.



The age of the displayed XM data

XM Weather Diagnostics

[CHECK] -> [MAINT] -> [ABOUT]

The ABOUT page displays pertinent information about the status of your XM Weather receiver.

Weather Status shows information for diagnosing weather module problems.

Mode: Shows the mode of that particular screen (MASTER or SLAVE).

Receiver ID: Shows the unique identification number of your receiver

Signal Strength: Indicates the current strength of the XM satellite signal (NONE, POOR, AVERAGE, GOOD)

Antenna: Indicates whether or not an XM antenna is connected

Last Data: The elapsed time from the point of the last weather data received.

Note: Weather Status will not be shown if WX is set as OFFLINE in Instrument Calibration.

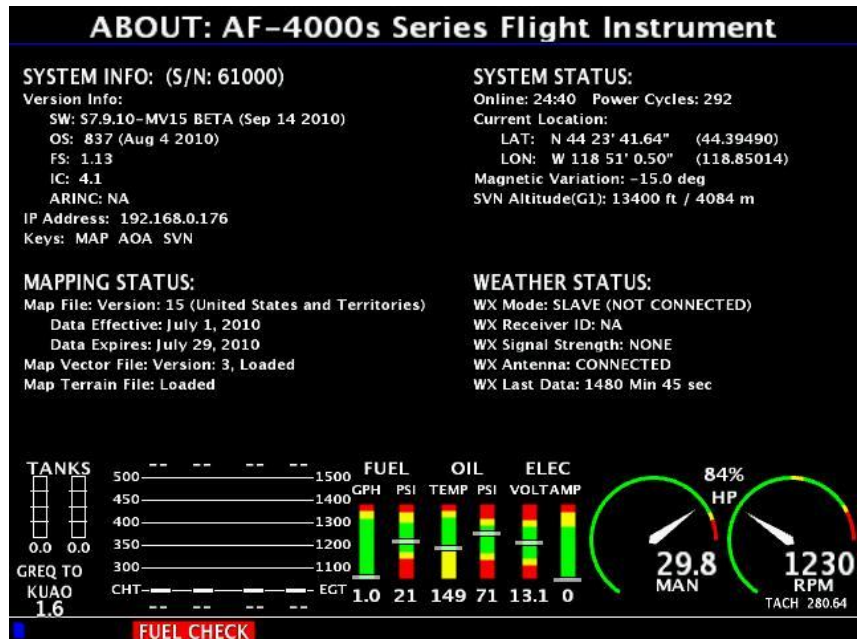

ADS-B Weather

Automatic Dependant Surveillance Broadcast is part of the FAA NEXTGEN system to increase aviation safety and awareness within the national aerospace system. One of the two products ADS-B provides is a free weather uplink service which includes the following products: METAR's, TAF's, TFR's, Winds Aloft and Lightning.

ADS-B Hardware

Current y AFS supports the NavWorx ADS600-B transceiver.

Installation

Please see Page 43 for installation details.

Screen Configuration Settings

Once the ADS600-B is installed and configured, the map page needs to be setup to view ADS-B weather information.

To enable ADS-B Weather go to any map page and press [SETTINGS] -> [WX] -> [WX: ADS-B]

The various weather products can also be turned on or off on that same WX menu.

NXRAD - NEXRAD Radar

LGHT - Lighting Strikes

WNDS - Winds Aloft

METAR's, TAF's, and TFR's are always on and not user selectable.

ADS-B Status Information

[CHECK] -> **[MAINT]** -> **[ABOUT]**

The ABOUT page displays pertinent information about the status of your ADS-B Weather receiver.

Weather Status - Shows status information about the ADS-B interface.

Not Parsing ADS-B Weather - The EFIS is not receiving FIS-B weather data

ADS-B Mode - Displays either Master or Slave mode (Unit wired to the ADS-B device will be Master)

Ownship Count - Number of messages the EFIS is receiving from the ADS-B device. Verifies connectivity

Aged Times - Elapsed time since the last data update (METAR, TAF, TFR, NEXRAD, Winds, Lighting)

Engine Monitor Display

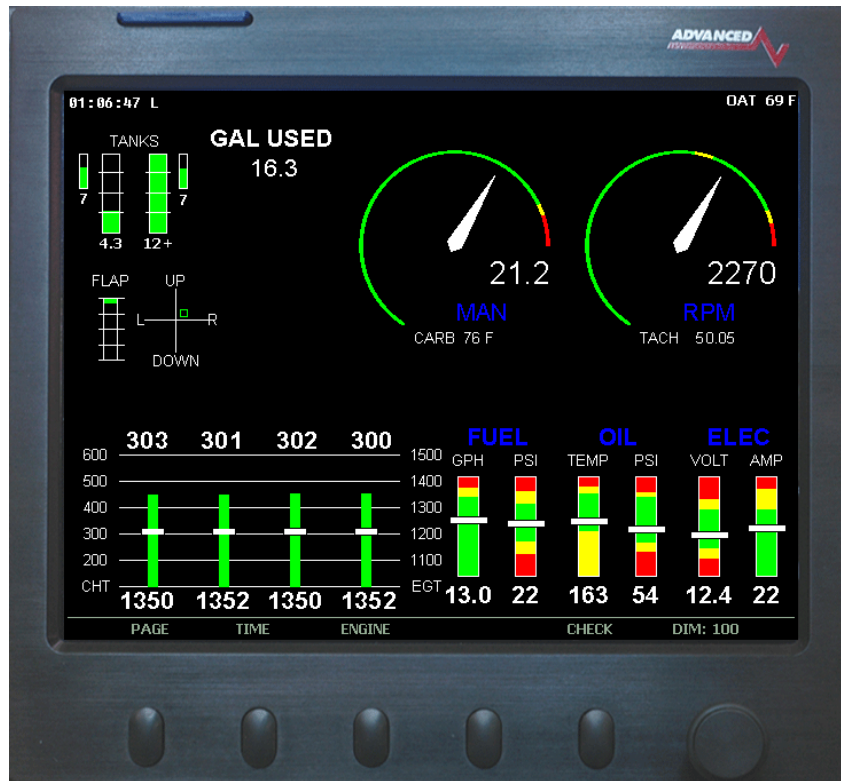

The system can display the engine monitor on the bottom of the main EFIS page or as a full Engine page if the system has one of the following:

1. The screen has an engine monitor board installed in the case.
2. The screen is connected to another screen that has an engine monitor board installed with an Ethernet crossover cable.

Fuel Computer

The fuel computer is accessed from the main screen by pressing the **[ENGINE]** button followed by pressing the **[FUEL]** button.



WARNING

The GALS USED (Gallons Used) and GALS REM (Gallons Remaining) displayed is not a measurement of the fuel in the aircrafts tanks. The fuel amount calculated from the starting fuel level you programmed in the system, minus the fuel used while the engine was running. When the system is properly calibrated and fuel is added correctly the system will accurately measure the fuel used. It is imperative the pilot verify the calibration of the system over many tanks of fuel before using the "GALS REM" and/or "GALS USED" Modes as an indication of the fuel in the tanks or fuel used. Even after verifying the calibration of the system it should never be used as the primary indicator of fuel quantity in the tanks. It is important the pilot visually check/measure the fuel quantity for each tank before takeoff and crosscheck these readings against the Fuel Level Gauges and the Fuel Computer. It is important the pilot use preflight and flight planning techniques, in accordance with the FAR's, which will help insure the proper amount of fuel for the intended flight is on board the aircraft before takeoff. While in flight the fuel gauges and fuel computer should only be used to crosscheck the fuel calculations of the fuel onboard from flow rates specified in the specification for your aircraft and calculations of the fuel onboard from flow rates that you measured from previous flights. The use of this system does not eliminate or reduce the necessity for the pilot to use good flight planning, preflight and in-flight techniques for managing fuel. If you are not familiar with these techniques, contact the FAA to acquire proper training.

Fuel Flow Calibration

The accuracy of the fuel computer is affected by the value of **Counts per .01 gals** (K Factor). The **Counts per .01 gals** (K Factor) sets the calibration of the instrument to match the flow transducer and the variations in the installation. After running a tank of fuel use the following formula to adjust the accuracy.

The **Counts per .01 gals** (K Factor) is adjusted from the Fuel Flow/Computer page in Instrument Calibration.

New Counts per .01 gals = (Old Counts per .01 gals) x (Disp GAL USED/PUMP GALS)

Fuel Computer Modes

The fuel computer display can set to display any of the following by pressing the **[MODE]** button. The mode label will be **RED** if the fuel computer gallons remaining amount does not match the fuel tanks.

Gallons Used -> Gallons Remaining -> Hours Remaining

If the system is connected to a GPS you will also have:

Kts per Gallon -> Miles per Gallon -> Gallons Remaining at Waypoint -> Gallons Required to Waypoint

WARNING: The Fuel Computer is only accurate when the fuel-flow sensor is calibrated properly and fueling stops are entered correctly.

GAL USED Gallons Used

Displays the gallons used since the last time the fuel computer was set.

GAL REM Gallons Remaining

Displays the gallons remaining, calculated from the last time the fuel computer was set.

HRS REM Hours Remaining

Displays the hours remaining, calculated from the last time the fuel computer was set and the current fuel flow rate.



WARNING!! The following are based on the current fuel flow and the GPS ground speed. If you change power settings or the Winds change they will not be correct!

NM/GAL Nautical Miles per Gallon

Displays the current ground distance traveled in nautical miles per gallon of fuel.

SM/GAL Statute Miles per Gallon

Displays the current ground distance traveled in statute miles per gallon of fuel.

GREM AT Gallons Remaining At Waypoint

Displays the fuel amount that should be remaining at the next GPS waypoint.

GREQ TO Gallons Required to next Waypoint.

Displays the fuel amount of fuel needed to get to the next GPS waypoint. This is based on the current fuel flow and GPS data.

Adding Fuel to the Fuel Computer

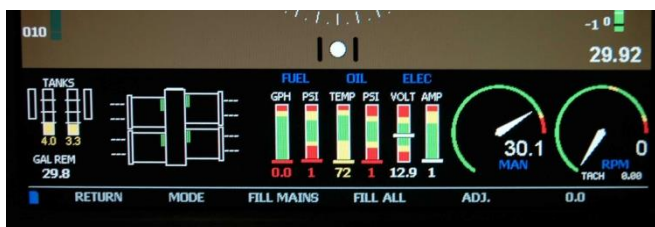

WARNING: Every time fuel is added or removed from the aircraft tanks one of the following operations must be done to protect the accuracy of the fuel computer.

TANKS FILLED

You can set the fuel computer to the programmed full tanks by pressing one of the following buttons in the fuel computer:

1. **[FILL MAINS]** If only the main tanks have been filled
2. **[FILL ALL]** If the main and tip tanks have been filled



WARNING: If you press **[FILL ALL]** and have not added fuel to the tip tanks the fuel computer calculations will be incorrect

You can add or subtract fuel to the computer by adjusting the **[KNOB]** for the correct amount and then pressing the **[ADJ]** button.

% Power Display

The system will display the estimated %Power using the Horsepower table in instrument calibration. You will need to configure the settings by using the appropriate data from your engine manual.

Instrument Calibration			
Configure Horsepower			
Config:			
1. Admin Settings			
2. Altitude			
3. Airspeed			
4. AOA			
5. Battery Voltage			
6. Primary Voltage			
7. Backup Voltage			
8. OAT			
9. Engine Type			
10. RPM			
11. Manifold			
12. Fuel Flow			
13. Fuel Computer			
14. Fuel Pressure			
15. Amperage (Shunt)			
16. Amperage (Hall-Effect)			
17. Oil Pressure			
18. Oil Temperature			
19. Exhaust Gas Temp (EGT)			
20. Cylinder Head Temp (CHT)			
21. Turbo Inlet Temp (TIT)			
22. Horsepower			
23. Carb Temp			
24. Tank 1			
25. Tank 2			
* 1. Rated Horsepower 180			
2. Instrument OFF/ON ON			
3. Num RPM Points 8			
4. Num ALT Points 7			
	RPM	MAP 55%	MAP 75%
	2000	21.6	26.7
	2100	21.0	26.0
	2200	20.3	25.2
	2300	19.8	24.6
	2400	19.2	23.9
	2500	18.9	23.5
	2600	18.6	23.2
	2700	18.2	22.7
	ALT	HP DELTA	
	2000	2.3	
	4000	4.6	
	6000	6.9	
	8000	9.1	
	10000	11.4	
	12000	13.7	
	14000	16.0	

RETURN NEXT PREV COPY SAVE <-(COL)-> DEMO

The following data is supplied only as a reference; you should use your Lycoming engine graphs to verify the accuracy of the display. The Delta HP number is the increase in actual HP that the engine will produce for the same manifold and RPM at increased Altitude.

Engine	O-360				
Rated HP	180				
RPM	55% MAP	75% MAP		Altitude	Delta HP
2000	21.6	26.7		2000	2.3
2100	21	26		4000	4.6
2200	20.3	25.2		6000	6.9
2300	19.8	24.6		8000	9.1
2400	19.2	23.9		10000	11.4
2500	18.9	23.5		12000	13.7
2600	18.6	23.2		14000	16
2700	18.2	22.7			

Engine	O-320				
Rated HP	160				
RPM	55% MAP	75% MAP		Altitude	Delta HP
2000	21.4	26.4		2000	2
2100	20.8	26		4000	4.1
2200	20	25.6		6000	6.1
2300	20.3	24.9		8000	8.1
2400	19.6	24.3		10000	10.1
2500	19.2	23.8		12000	12.2
2600	18.8	23.2		14000	14.2
2700	18.4	23.1			

Engine	IO-540				
Rated HP	260				
RPM	55% MAP	75% MAP		Altitude	Delta HP
2000	23.2	29.4		2000	5
2100	22.4	28.1		4000	9
2200	21.5	26.8		6000	13
2300	20.7	25.7		8000	17
2400	19.8	24.7		10000	21
2500	19.3	24		12000	25
2600	18.8	23.3		14000	29
2700	18.5	22.5			

EGT/CHT Display Modes

The Exhaust Gas Temperatures (EGT) and Cylinder Head Temperatures (CHT) for every cylinder are continuously displayed in both analog and digital formats on the AF-3400/3500. The cylinders are laid out sequentially with cylinder #1 on the left followed by cylinder #2 to its right and so on. The graph uses small white bars for the CHT that are superimposed onto the larger EGT bars. The graph uses a dual scale that represents the CHT scale on the left side and the EGT scale on the right. The digital reading for each

column is displayed above each bar for CHT and below for EGT. During normal operation the EGT and CHT bars will align themselves in a very easy to recognize pattern.

Leaning EGT Mode (Peak Detect)

The leaning peak detection mode is selected from the main screen by pressing the **[ENGINE]** -> **[EGT/CHT]** -> **[PK DET OFF]** buttons. As you lean the engine, the EGT bars for all cylinders will rise. As each cylinder reaches peak EGT, a tattletale marker will appear at the top of that cylinder's bar. The current EGT is shown on the bottom of the bar, Peak EGT is displayed on the top and the degrees rich or lean of peak are displayed on the bar. If you start to richen the engine before all cylinders have peaked the unit will detect the EGT drop and display a false peak. The peak detection can be reset at any time by pressing the **[PK DET ON]** then **[PK DET OFF]** button.



Warning: You should never lean your engine with power settings over the factory recommended level (generally 65% to 75% power).

Leaning with high power settings can cause detonation. Always verify your power level with engine charts before leaning. As you lean past maximum horsepower (100F to 150F rich of peak EGT) your engine will lose power.

Flight Times

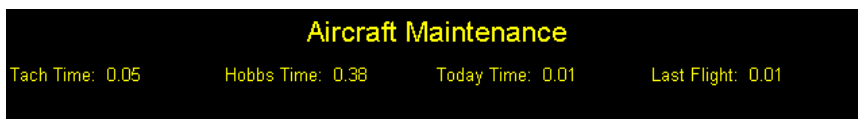

Flight times are displayed on the top of the maintenance check list page. Press the **[CHECK]** button followed by the **[MAINT]** button.

Tach Time: Hours on engine above 1250 RPM.

Hobbs Time: Hours on engine above 0 RPM.

Last Flight: Hobbs time for the last flight.

Today: Hobbs time since 12:00 AM today.

Check Lists

To view your checklists pages press the **[CHECK]** button from the main screen. Use the **[NEXT]** and **[PREV]** buttons to scroll through the checklists. To return to the main screen press the **[RETURN]** button.

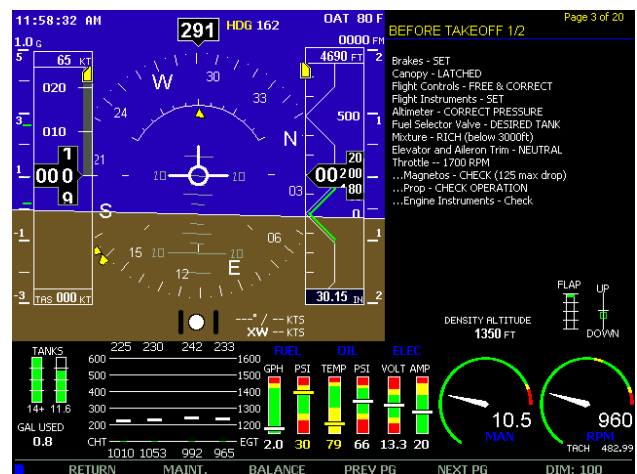

If the **[CHECK]** button is pressed the page that is displayed is controlled by the following:

ENGINE RPM	PAGE	Normal Use
0	1	Before Starting Engine
<1250	3	Before Takeoff Checklist
>1250	6	Emergency Checklist

This will make the emergency procedures check list easy to access in the event of an in flight emergency.

The checklist file is stored in the **CHKLST.AFD** file and can be transferred using the SD card from the EFIS Calibration Menu (CHECK -> MAINT -> ADMIN ->CALIBRATION).

1. Admin Settings

1. Transfer Files

2. Checklists file

Rotate the right knob to BACKUP and press START

The text for the checklists is stored in the following format and can be modified using Microsoft Word Pad on a PC.

```
# Lines are limited to 96 char long
#
# DO NOT USE COMMAS IN THE CHECKLIST TEXT !

CHKLST0.TITLE, BEFORE STARTING ENGINE
CHKLST0.LINE1, Preflight Complete
CHKLST0.LINE2, Spar Pins Secured - CHECK
CHKLST0.LINE3, Safety Belts - ON
CHKLST0.LINE4, Doors - LATCHED
CHKLST0.LINE5, Fuel Selector Valve - DESIRED TANK
CHKLST0.LINE6, Avionics - OFF
CHKLST0.LINE7, Brakes - SET
CHKLST0.LINE8, Circuit Breakers - CHECK IN
CHKLST0.LINE9,
CHKLST0.LINE10,
CHKLST0.LINE11,
CHKLST0.LINE12,

CHKLST1.TITLE, ENGINE STARTING
CHKLST1.LINE1, Mixture - RICH
CHKLST1.LINE2, Prop - HIGH RPM
CHKLST1.LINE3, Master Switch - ON
CHKLST1.LINE4, Fuel Boost Pump (3 Sec)
CHKLST1.LINE5, Flaps - UP
CHKLST1.LINE6, Throttle - OPEN approx 1/4
CHKLST1.LINE7, Propeller Area - CLEAR
CHKLST1.LINE8, Ignition Switch - START
CHKLST1.LINE9, Oil Pressure - CHECK

CHKLST1.LINE10, Strobes - ON
CHKLST1.LINE11,
CHKLST1.LINE12,

CHKLST2.TITLE, BEFORE TAKEOFF 1/2

CHKLST2.LINE1, Brakes - SET
CHKLST2.LINE2, Spar Pins Secured - CHECKED
CHKLST2.LINE3, Doors - LATCHED
CHKLST2.LINE4, Flight Controls - FREE & CORRECT

CHKLST2.LINE5, Flight Instruments - SET
CHKLST2.LINE6, Altimeter - CORRECT PRESSURE
CHKLST2.LINE7, Fuel Selector Valve - DESIRED TANK
CHKLST2.LINE8, Mixture - RICH (below 3000ft)
CHKLST2.LINE9, Elevator and Aileron Trim - NEUTRAL
CHKLST2.LINE10, Throttle -- 1800 RPM
CHKLST2.LINE11, ...Magnetos - CHECK (175 max drop)
CHKLST2.LINE12, ...Prop - CHECK OPERATION
```

To restore the checklist file to your EFIS perform the same steps above but instead rotate the right knob to say RESTORE and press SELECT.

Maintenance Log

The system has an Aircraft Maintenance Log that can be setup to track any number of user configurable items. Each item can be configured as a Tach time or calendar time controlled event. Once the time interval has expired the item will turn red indicating the need for service.

AF-3000 AF-4000 Manual V 7.6

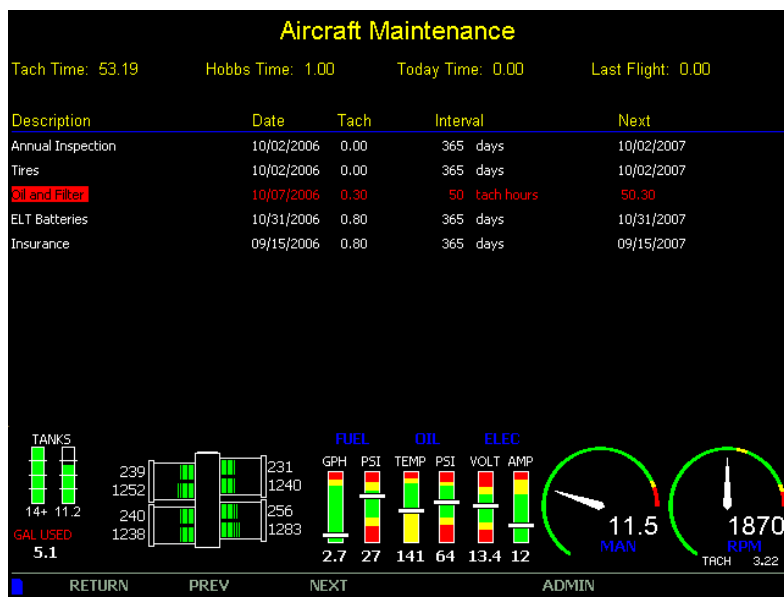

You can set any items Date and Tach Time to the current values from the Aircraft Maintenance page: **[ADMIN]** -> **[UPDATE]** buttons.

The Maintenance Log is selected from the following menu:

[CHECK] -> **[MAINT]**

The Maintenance settings are controlled by the file:

MAINT.AFD

The file is in the following format and can be modified using Microsoft Word Pad on a PC.

Units must be **Tach hours** or **days**.

```
DESC, Annual Inspection
LASTDATE, 08-05-2006
LASTTACH, 210.80
INTERVAL, 250
UNITS, tach hours
NEXTLINE, 0
DESC, Tires
LASTDATE, 04-05-2005
LASTTACH, 95.10
INTERVAL, 365
UNITS, days
NEXTLINE, 0
DESC, Oil and Filter
LASTDATE, 06/19/2006
LASTTACH, 195.30
INTERVAL, 100
UNITS, tach hours
NEXTLINE, 0
DESC, ELT Batteries
LASTDATE, 08/05/2006
LASTTACH, 210.80
INTERVAL, 400
UNITS, days
NEXTLINE, 0
DESC, Insurance
LASTDATE, 08/05/2006

LASTTACH, 210.80
INTERVAL, 180
UNITS, days
NEXTLINE, 0
```

You can transfer the file to and from the SD card from the EFIS Calibration startup screen (CHECK -> MAINT -> ADMIN -> CALIBRATION).

1. Admin Settings

1. Transfer Files

3. Maintenance

Rotate the right knob to BACKUP (if you want to copy it to your SD card) or RESTORE (if you want to copy the file from your SD card to your EFIS) and press START

Weight & Balance Screen

The Weight & Balance page is selected from the following menu:

[CHECK] -> **[MAINT]** -> **[BALANCE]**

The PREV & NEXT buttons are used to select the station and the knob is used to adjust the weight of the station or volume for fuel.

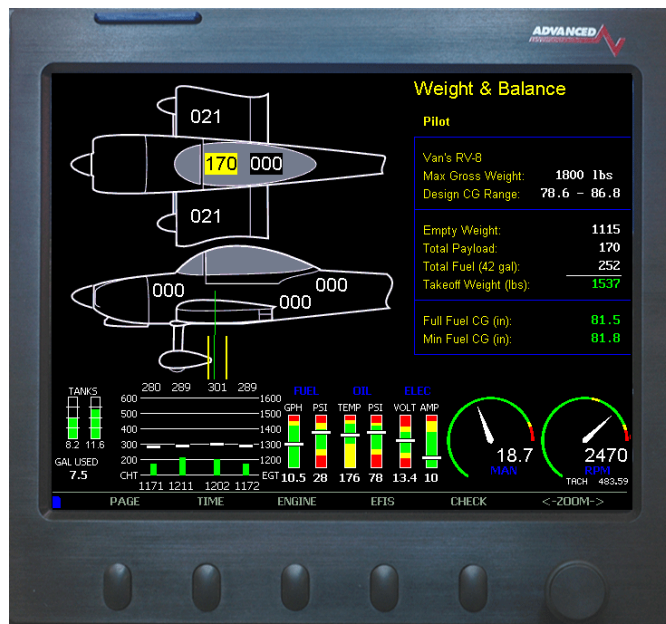

The Weight & Balance settings are controlled by the files:

AIRCRAFT.AFD Stations, Weights, Screen Location

AIRCRAFT.AFB Standard .BMP of the aircraft picture.

You can transfer the files to and from the SD card from the EFIS Calibration startup screen (CHECK -> MAINT -> ADMIN -> CALIBRATION).

1. Admin Settings

1. Transfer Files

4. Weight & Balance

The normal weight & balance settings can be adjusted on the Weight & Balance page by pressing the **[STATIONS]** button. The X and Y on the stations page is the screen coordinates for the text on the aircraft bitmap. The Aircraft Type, Gross Weight and CG Range will need to be modified using Microsoft Word Pad and editing the AIRCRAFT.AFD file on a PC.

The aircraft bitmap can be changed using Microsoft Paint and editing the AIRCRAFT.AFB file, do not change the overall dimensions of the Bit Map.

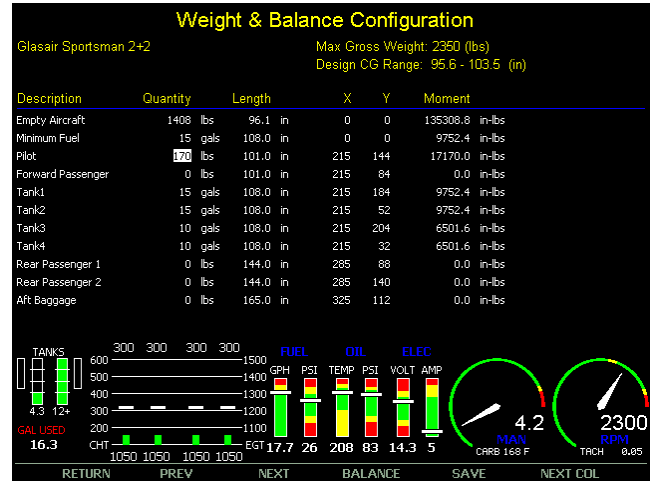

Flight Data Logs

Flight Data from the system is downloaded using the SD data card from the Maintenance checklist page. To download flight data do the following:

1. Place an SD card in the Screen
2. Press **[CHECK]** -> **[MAINT.]** -> **[ADMIN]** -> **[DATA LOGS]**
3. The last flight time will be displayed over the knob; you can select the amount of flight time to download using the knob. (Rotate it to the right to increase time with a max. of 12hrs)
4. Press **[START]** to transfer the selected stored flight data onto the SD Card.

Importing Flight Data to Excel

Once you save data from the Engine Monitor you can import the data into Microsoft Excel by the following procedure:

1. From Excel select File **Open**
2. Change the file type to All Files (*.*)
3. Open your SD drive folder
4. Select the *.ALD file to open. The data files are stored using the following name:

yymmddhhmm.ALD where

y year
mm month
dd date
hh hour
m minute

5. The Text Import Wizard should start and look like this:

Select **Delimited**

Click **Next**

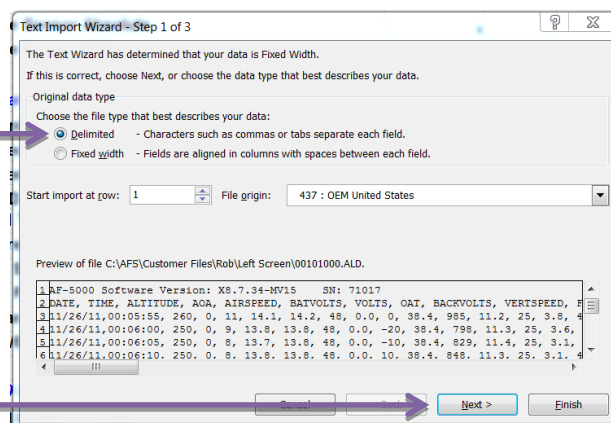

Select **Comma**

Click **Finish**

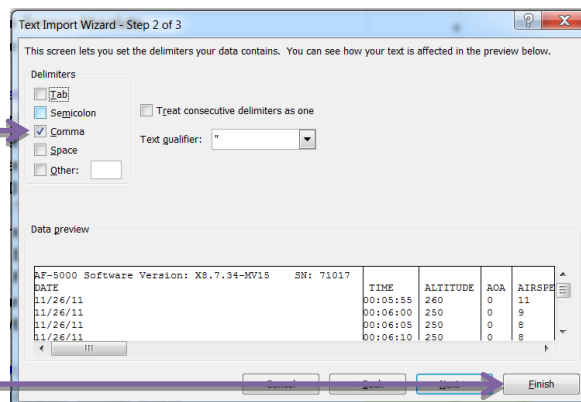

AF-3400/AF-3500/AF-4500 Installation

Mechanical Mounting

The Display should be mounted from the rear of the instrument panel with four 6-32 screws. Allow clearance for the connectors on the rear. See the Appendix B: for proper dimensions. The rear connectors are 5.5" from the front panel and the plugs require another 3" for clearance. The case ground screw in the middle of the decal should be connected to the main aircraft ground buss with a #18 agw wire.

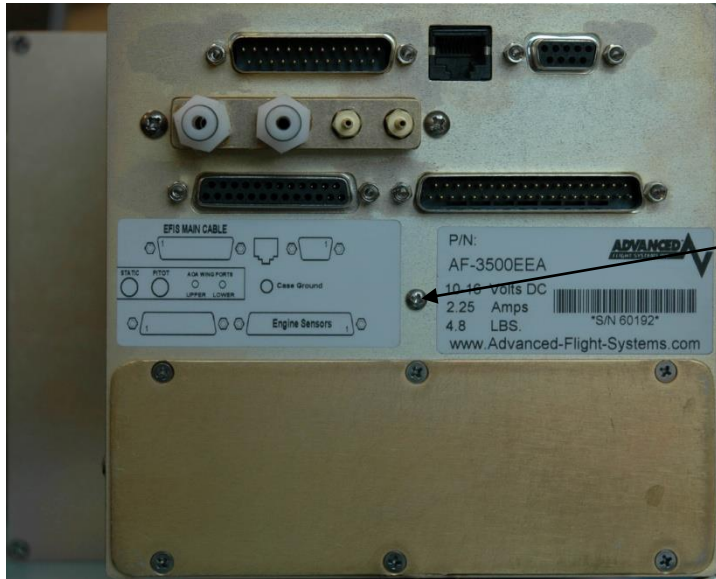

Case Ground Screw

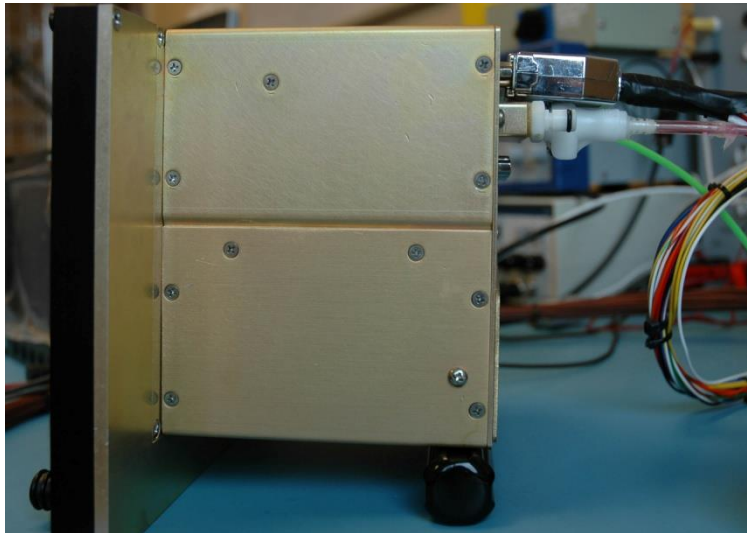

Electrical Connections

For wiring information see APPENDIX M:

The AF-3000/4000 series power requirement is 12 volts at 2.5 Amps, a 3 amp circuit breaker or fuse should be used for the system.

All wire should meet Mil Standard MIL-W-22759/16 (Tefzel insulation)

20 AWG wire is normally sufficient for the power supply and ground wires.

Pin 1 Red Master Power

Pin 3 Black Ground

*Pin 15 N/C Backup Power

*Backup Power input is used for a dual electrical system.

CAUTION: The screen case and sensors must have a good ground to the aircraft battery. The case grounding screw should be connected with at least a 20 agw wire to the main aircraft ground buss.

Audio Connections

If two EFIS units are being installed, the audio from only 1 units needs to be connected. All alerts are passed through the Ethernet network.

The harness is wired for a 560-ohm audio output that allows you to match the output impedance of the system to standard aircraft audio panel and intercom audio devices. If your radio or audio panel does not have an unswitched audio input you will need to purchase a audio mixer. Do not attempt to connect the EFIS audio to a music input on an intercom, they are not the same impedance and it will not be loud enough. Do not attempt to connect the EFIS audio along with a com radio to the same intercom input.

We recommend the following audio mixer if you do not have an audio panel:

http://www.fdatasystems.com/AP_60.htm



For wiring information see APPENDIX M:

Volume Adjustment

The volume can be adjusted from Instrument Calibration.

32. Test Audio

The range is (0%-100%) and is adjusted using the knob followed by pressing the **[SAVE]** button. The Test Audio menu will play all the sounds in the system.

EFIS Serial Data Connections

Each AF-3400/3500/4500 screen has four serial ports that can be used for external equipment (GPS, NAV, Traffic, FADEC Engine, ect..) communication. Not all functions are available on all serial ports so you should review the options before wiring external equipment to a serial port.

If you have more than one screen installed in your aircraft and they are connected with Ethernet you can share the serial ports between screens. For the serial ports and navigation sources (GPS, NAV) to work properly you will need to configure the actual serial port number hardware settings as well as assign an EFIS navigation source to a serial port number. The following steps should be followed in order:

STEP 1

Serial Port # Function Hardware Setup

This is where you configure each serial port for the external device that is physically wired to the port. You will need to know which serial port each device is wired to on the screen and what the external devices communication settings are. From **[Instrument Calibration]** mode you should select the following menu to configure each Serial Port:

[1. Admin Settings] ->

Serial Port #	Options	Notes
Serial Port #1-4 Functions	DISABLED	Nothing wired to port
	Ext. AHRS	External AHRS input
	NMEA @ 4800	External GPS with NMEA @ 4800 baud
	TRFC/ICARUS	Garmin Traffic In / ICARUS Out
	SL-30	Garmin SL-30 radio connected
	ARINC	AF-ARINC module connected to port
	AVTN/CHELTON	Chelton Engine Data Out
	AVTN/ARNAV	430W/530W or GPS with Aviation format
	FADEC SBC-100	FADEC Data In
	FADEC SBC-250	Do Not Use
	OP TECH	OP Engine Data Out
	NMEA/AVTN	NMEA 9600 In / AVIATION Out
	TRFC/SHADIN ALT	Garmin Traffic In/ SHADIN Out
1200 Baud	GARMIN AT	Garmin AT format, Dynon gray code converter
	MAGELLAN	Transponders set to MAGELLAN format
	NORTHSTAR	Transponders set to NORTHSTAR format
	AFS GPS	AFS GPS
	TRAFFIC	Garmin Traffic format (GTX 330, Zaon, ADS-B)
	AVTN/AVTN	Aviation In / Aviation Out
	VPX	Vertical Power VP-X Interface
	COGUARD	CO Guardian Interface
	ADSB	NavWorx ADS-B Interface

NOTES: STEP 1 should be done for all screens in the aircraft and only configured for the equipment that is physically connected to that screens serial ports.

STEP 2

GPS/NAV # Data Source Software Setup

This is where you configure the three available EFIS CDI and Moving Map data sources (GPS/NAV 1,2,3) to their assigned serial ports. The data sources for multiple screens must be configured to the same navigation source. If you configure GPS/NAV1 as Serial Port 4 (ARINC Module connect to Port #4) on the left screen the right screen must be set GPS/NAV1 as Remote ARINC. This configures the EFIS to read the data from the ARINC port anytime **GNAV 1** is selected from either screen.

From [Instrument Calibration] mode you should select the following menu to configure each GPS/NAV Data Source:

[1. Admin Settings] ->

GPS/NAV #	Options	Notes
10. GPS/NAV 1-3 Data Source*	NONE	No connected Nav or GPS
	Serial Port #1	GPS or Nav Radio Connect to Serial Port #1
	Serial Port #2	GPS or Nav Radio Connect to Serial Port #2
	Serial Port #3	GPS or Nav Radio Connect to Serial Port #3
	Serial Port #4	GPS or Nav Radio Connect to Serial Port #4
	Remote GPS	GPS connected to remote screen
	Remote ARINC	GPS/NAV connected to remote screen ARINC
	Remove NAV	SL-30 connected to remote screen.

NOTES:

**If you have an ARINC module it must be configured as the GPS/NAV1 Data Source.*

***If you have a second ARINC module it must be configured as the GPS/NAV2 Data Source.*

Depending on the type of Nav Radio connected to the GPS/NAV data source it will be displayed on the screen as one of the following:

GNAVx	GPS Navigator 430W/530W/480
GPSx	GPS Only Unit
NAVx	SL30 Nav Radio

Where x is the order number of the GPS or Nav radio, a GPS Navigator has a GPS and a Nav radio and will be displayed as GNAV1 for the first unit and GNAV2 for the second.

EFIS Serial Port Configuration Examples

The following examples should help you configure your system:

<Example #1> Single Screen, Garmin 496, GTX 327 and SL30

5. Serial Port #1 Function	NMEA/AVTN	Garmin 496 GPS
6. Serial Port #2 Function	TRFC/ICARUS	Garmin GTX 327 Transponder
7. Serial Port #3 Function	SL-30	SL30 Nav/Com
8. Serial Port #4 Function	DISABLED	
9. Serial Port Network Sharing	DISABLED	
10. GPS/NAV 1 Data Source	Serial Port #1	GPS 1
11. GPS/NAV 2 Data Source	Serial Port #3	NAV 1
12. GPS/NAV 3 Data Source	NONE	

<Example #2> Single Screen with AF-ARINC, Garmin 430W, GTX 327 and SL30

5. Serial Port #1 Function	AVTN/ARNAV	Garmin 430W GPS RS-232 Port
6. Serial Port #2 Function	TRFC/ICARUS	Garmin GTX 327 Transponder
7. Serial Port #3 Function	SL-30	SL30 Nav/Com
8. Serial Port #4 Function	ARINC	AF-ARINC Module -> 430W
9. Serial Port Network Sharing	DISABLED	
10. GPS/NAV 1 Data Source	Serial Port #4	GNAV 1
11. GPS/NAV 2 Data Source	Serial Port #3	NAV 2
12. GPS/NAV 3 Data Source	NONE	

<Example #3> Single Screen with AF-ARINC, Garmin 430W, GTX327, FADEC Engine

5. Serial Port #1 Function	AVTN/ARNAV	Garmin 430W GPS RS-232 Port
6. Serial Port #2 Function	TRFC/ICARUS	Garmin GTX 327 Transponder
7. Serial Port #3 Function	FADEC SBC-100	FADEC Engine Controller
8. Serial Port #4 Function	ARINC	AF-ARINC Module -> 430W
9. Serial Port Network Sharing	DISABLED	
10. GPS/NAV 1 Data Source	Serial Port #4	GNAV 1
11. GPS/NAV 2 Data Source	NONE	
12. GPS/NAV 3 Data Source	NONE	

<Example #4> Dual Screen with AF-ARINC, Garmin 430W, GTX 330, SL30, 496

SCREEN 1 (430W, GTX330, SL30)

5. Serial Port #1 Function	AVTN/ARNAV	Garmin 430W GPS RS-232 Port
6. Serial Port #2 Function	TRFC/ICARUS	Garmin GTX 330 Transponder
7. Serial Port #3 Function	SL-30	SL30 Nav/Com
8. Serial Port #4 Function	ARINC	AF-ARINC Module -> 430W
9. Serial Port Network Sharing	ENABLED	
10. GPS/NAV 1 Data Source	Serial Port #4	GNAV 1 -> 430W
11. GPS/NAV 2 Data Source	Serial Port #3	NAV 2 -> SL30
12. GPS/NAV 3 Data Source	REMOTE GPS	GPS 2 -> 496 from other screen

SCREEN 2 (496)

5. Serial Port #1 Function	NMEA/AVTN	Garmin 496
6. Serial Port #2 Function	DISABLED	
7. Serial Port #3 Function	DISABLED	
8. Serial Port #4 Function	DISABLED	
9. Serial Port Network Sharing	ENABLED	
10. GPS/NAV 1 Data Source	REMOTE ARINC	GNAV 1 -> 430W from other screen
11. GPS/NAV 2 Data Source	REMOTE NAV	NAV 2 -> SL30 from other screen
12. GPS/NAV 3 Data Source	Serial Port #1	GPS 2 -> 496 this screen

Screen 1

Serial Port #	Preferred Use	Device	Data Format	NAV Data Source Label (GNAVx GPSx NAVx)
Serial Port #1	GPS RS-232			
Serial Port #2	Encoder/Traffic			
Serial Port #3	SL30, ARINC			
Serial Port #4	ARINC, AF-GPS			

Screen 2

Serial Port #	Preferred Use	Device	Data Format	NAV Data Source Label (GNAVx GPSx NAVx)
Serial Port #1	GPS RS-232			
Serial Port #2				
Serial Port #3	SL30, ARINC			
Serial Port #4	AF-GPS			

Screen 3

Serial Port #	Preferred Use	Device	Data Format	NAV Data Source Label (GNAVx GPSx NAVx)
Serial Port #1	GPS RS-232			
Serial Port #2				
Serial Port #3				
Serial Port #4				

External Device Configuration

AF-ARINC 429 ADAPTOR

The AF-ARINC adaptor provides 2 serial inputs for display of navigation data (VOR, ILS, GPS, LPV) from a Garmin 430W/530W/480 and 1 serial output. The ARINC 429 output can be connected to multiple ARINC 429 receivers; 430W, 530W, 480, and Autopilots that support GPS steering commands. The AF-ARINC module should be connected to EFIS Serial Port #3 or Serial Port #4.

For ARINC module wiring information see APPENDIX M, drawing number: 53620WD

CO Guardian Display

Currently, the new “s” mode processor will display data from any of the CO Guardian units that support RS-232 MFD output. The current cabin CO level is displayed on any of the Check List pages. If the CO Guardian device generates a warning, the current CO level will be displayed as a pop up message on the EFIS screen. If you have the new Aero-455 (CO, heart rate, O2 level) monitor, the data will be displayed as a pop up message after about 20 seconds of monitoring you finger. The CO Guardian should be wired to any open serial port and then the serial port Admin setting set to CO Guardian.



Garmin 430W/530W

The 430W/530W should be wired for RS-232 Aviation format to serial port #1 along with their ARINC lines connected to the AF-ARINC module. *See APPENDIX M, drawing number: 53620WD*

<u>EFIS Main Cable</u>	<u>430W RS-232 Connection</u>
Pin 10 TXD -----	4001-57 RX
Pin 22 RXD -----	4001-56 TX

The 430W/530W needs the following software configuration settings:

1. MAIN ARINC 429 CONFIG

Power up the 430W while holding the ENTER button and press [ENT] -> [ENT] to get to the Main ARINC 429 Config page. Configure the 430W using these settings. **OUT must be set to GAMA 429.**

2. VOR / LOC / GS ARINC 429 CONFIG

Turn the inside right knob around 14 clicks to configure the VOR/LOC/GS ARINC 429 to the following settings.

3. Serial Ports

Select ARNAV/ei-fuel for the input and Aviation as the output.



430W/530W ARINC 429 Verification Test

The 430W/530W communicates with the ARINC module using two separate serial ARINC ports. VOR data is sent on one ARINC port and GPS data is sent on the other ARINC port. You should verify that both ports are working after wiring and configuring the EFIS and 430W/530W.

1. EFIS to AF-ARINC Module Communication Test

Boot the EFIS in CONFIG mode and select: 1. Admin Settings -> 21. Diagnostics -> 8. ARINC VOR Test

If the ARINC module is wired to the EFIS correctly it should find the adaptor and you should see the **Message Count** increasing. If the EFIS does not find the adaptor the problem is between the AF-ARINC adaptor and the EFIS and you should check the following:

- Power to the AF-ARINC module, you can remove the AF-ARINC cover and check for a green light.
- Wiring between the EFIS serial port and ARINC Module.
- Serial Port setup on the EFIS Admin Settings page.

```
Instrument Calibration
Perform Diagnostics Tests
Config:
1. Admin Settings
2. Altitude
3. Airspeed
4. AOA
5. Battery Voltage
6. Primary Voltage
7. Backup Voltage
8. OAT
9. Engine Type
10. RPM
11. Manifold
12. Fuel Flow
13. Fuel Computer
14. Fuel Pressure
15. Amperage (Shunt)
16. Amperage (Hall-Effect)
17. Oil Pressure
18. Oil Temperature
19. Exhaust Gas Temp (EGT)
20. Cylinder Head Temp (CHT)
21. Turbo Inlet Temp (TIT)
22. Horsepower
23. Carb Temp
24. Tank 1
25. Tank 2

ARINC adapter is alive.
Bootloader/Application version: B4 / V2.1
Message Count: 26
VOR data
030220F9 Equipment: Garmin Airborne VOR Receiver
2F2AC01C Frequency: 117.95 VOR
3A880292 BrgToAct(x10): 0823
FE588240 Course(x10): 3577 VLOC
6060027B Localizer: 301 R
0000007C Glideslope: 0 D
```

2. ARINC to 430W/530W VOR Communication Test

If the ARINC VOR side is wired to the 430/530 correctly and configured you should see some or all of the VOR data from the radio. Data shown is RED is flagged from the radio and caused by a weak VOR signal.

3. ARINC to 430W/530W GPS Communication Test

Select: 1. Admin Settings -> 21. Diagnostics -> 9. ARINC GPS Test

If the ARINC GPS side is wired to the 430/530 correctly and configured you should see some or all of the GPS data from the radio. Data shown is RED is flagged from the radio

```
Instrument Calibration
Perform Diagnostics Tests
Config:
1. Admin Settings
2. Altitude
3. Airspeed
4. AOA
5. Battery Voltage
6. Primary Voltage
7. Backup Voltage
8. OAT
9. Engine Type
10. RPM
11. Manifold
12. Fuel Flow
13. Fuel Computer
14. Fuel Pressure
15. Amperage (Shunt)
16. Amperage (Hall-Effect)
17. Oil Pressure
18. Oil Temperature
19. Exhaust Gas Temp (EGT)
20. Cylinder Head Temp (CHT)
21. Turbo Inlet Temp (TIT)
22. Horsepower
23. Carb Temp
24. Tank 1
25. Tank 2

ARINC adapter is alive.
Bootloader/Application version: B4 / V2.1
Message Count: 17
GPS data
0480A0B0 Date/Time: 04/01/2005 11:38:48
030046F9 Equipment: Garmin Flight Mgmt. Comp
000006B1 Flags: integrity: OK phase: ENR
C7F06640 Course(x10): 2811 GPS
C7A0064C Des.Track(x10): 2807 true
C7A0064D WP Bearing(x10): 2807
0000064E CrossTrk(x100): 0 Naut Mi
0000024F Vert. Dev.: 0 ft TRK
020006D6 Lat. Scl Fctr(x10): 20 nM
000002D7 Vert Scale Fctr: 0 ft
BED6FEC9 Lat/Lon: 45.4316 -91.6316
000002D0 Mag Heading(x10): 0000 var: 4 E
028006CA Ground Speed(x10): 800 kts
C7A006CB Track(x10): 2807 true
28E006A9 Dist to WP(x10): 13096
000002AA Time to WP: 00:00
0900063D To WP ID: KUAO
00B4BEC3 WP header: 22
```

ARINC Module Software Updating

Boot the EFIS in CONFIG mode and select: 1. Admin Settings -> 20. System Maintenance -> 3. Upgrade ARINC Software

Procedure

1. Download the latest ARINC software from the AFS support page.
<http://www.advanced-flight-systems.com>
2. Unzip the ARINC.zip file, and place the ARINC.HEX file onto a SD card.
3. Insert the card into the unit and navigate to the page shown at right.
4. Cycle power to the ARINC adaptor. If the ARINC module is powered on the same source as the EFIS the internal EFIS battery should keep the EFIS running during the power cycle.
5. Press the start button to begin loading the new code. The screen will say, "Loading....xxx". Where xxx is the number of bytes transferred.
6. When the screen prints "Done.", you can remove the card and reboot the ARINC module.
7. Verify that the ARINC software version was updated from the following menu after the EFIS is running in normal mode: **[CHECK] -> [MAINT.] -> [ABOUT]** The ARINC software version should be displayed in the list.

Now the ARINC module is ready for use.

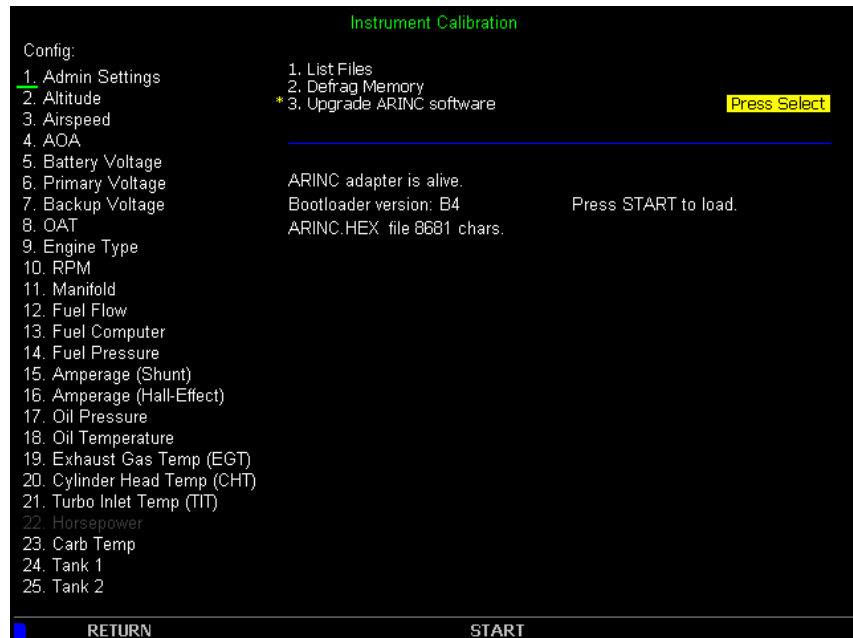

Garmin SL-30

The AF-3000 will send/receive data from a SL30 on EFIS Serial Port #3. The EFIS can get VOR/LOC/GS data from the SL30 and can set the OBS setting on the SL30. If the EFIS is also connected to a Garmin 396/496 it will pass through any radio frequency tuning commands to the SL30.

<u>EFIS Main Cable</u>		<u>SL30</u>	<u>37 Pin Connector</u>	
Pin 4	TXD	-----	Pin 4	RX
Pin 5	RXD	-----	Pin 5	TX
Pin 21	GND	-----	Pin 3	GND

The **Indicator Head Type** setting should be set to **NONE** in the SL30. This will enable the OBS to be set from the SL30 buttons and from the EFIS.

Garmin 396/496

- The 396/496 can send RS-232 data in NMEA 4800 Baud format **or** NMEA & VHF 9600 Baud. If you also have a SL30/SL40 connected you should use the NMEA & VHF 9600 Baud setting in the GPS. This will enable you to set the standby radio frequency on the SL30 from the GPS. Make sure that you use the same baud rate setting in the GPS and EFIS Admin setup.
- The NMEA output rate on the 396/496 must be set to normal.**
To access the Advanced NMEA Output Setup:
 - Press MENU twice to open the Main Menu.
 - Use the ROCKER to select Setup from the vertical tab list.
 - Select Interface from the row of tabs along the top.
 - Highlight the field below Serial Data Format. Press ENTER
 - Select NMEA In/NMEA Out. Press ENTER
 - Press MENU to open the options menu. Select Advanced NMEA Setup and press ENTER.



Advanced NMEA Output Setup

Garmin GTX 327 / GTX 330 Transponder

The AF-3000 can act as the altitude encoder and send the current pressure altitude on EFIS Serial Port #2. The GTX 327 / GTX 330 should be configured for ICARUS altitude format. The EFIS can also be configured to receive traffic data from the GTX 330 for the moving map. The GTX 330 should be set for Serial 1 ICARUS Input and REMOTE/TIS output.

<u>EFIS Serial Port</u>	<u>EFIS Main Cable</u>	<u>GTX 327</u>	<u>GTX 330</u>
Serial Port #2 TXD	Pin 13	Pin 19	Pin 22
Serial Port #2 RXD	Pin 25	none	Pin 23

NOTE: The only time an altimeter and your transponder altitude will agree is when you have the baro set at 29.92. All transponders require pressure altitude referenced to standard pressure (29.92 in. Hg). The computers at the air traffic control center automatically adjust your altitude for the pressure offset. Why is this done? If it was not done this way the altitude that all the planes were reporting would be based on whatever setting a pilot had set and you would have a possibility for human error.

Chelton or OP EFIS

The AF-3400/3500/4500 can send Airdata and Engine Data to a Chelton or OP EFIS from serial Port #3 or Port #4.

<u>EFIS Serial Port</u>	<u>Pin</u>	<u>Chelton</u>	<u>OP</u>
Serial Port #3 TXD	EFIS Main Cable Pin 4	Pin	Pin
Serial Port #4 TXD	EFIS Aux (DB9) Port Pin 1	Pin	Pin

See **Serial Port # Function Hardware Setup** for Serial Port configuration

EFIS Sensor Installation

Magnetometer Installation

The Remote Magnetometer P/N: 8350-0480 must be mounted so that its orientation is as closely aligned with the AF-3400/3500/4500 EFIS screen as possible. It should be mounted with the electrical connector facing toward the front of the plane, and the mounting tabs on the bottom. The bracket used to hold the remote magnetometer must account for all differences in angles between the EFIS and the remote Magnetometer. This includes pitch, roll, and yaw. We recommend you use an electronic level that reads to 1/10th of a degree to make sure it is aligned with the EFIS in pitch and roll to better than 2/10th of a degree. Dual Magnetometers should be mounted 10" apart from each other.



Mounting Location

The remote magnetometer must not be located within 24 inches of any large, moving, ferrous metal objects such as landing gear components, motors, steel control cables or linkage. Avoid any metallic objects that may change position between ground operations and flight operations, such as landing gear, flap actuators, and control linkages.

The remote magnetometer should not be located close to high current DC power cables or 400 cycle AC power cables and their associated magnetic fields. Wires carrying high currents, alternate currents, or intermittent currents can cause magnetic variations that will affect the unit. Keep wires with these characteristics at least 24 inches away from the remote magnetometer. These wires can include:

- Battery wires
- Strobe wires
- Autopilot control wires
- Position light wires

Mounting Hardware

The remote magnetometer should be mounted using 6-32 brass or aluminum screws and nuts.

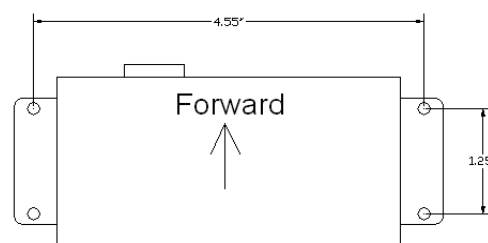

Wiring Connections

The remote magnetometer is connected to the EFIS Main Cable P/N: 53600 using the supplied 4 conductor shielded cable. Route the 4 conductor cable from the EFIS to the magnetometer, trim the cable to length and solder the DB-9 female plug using the following:

EFIS DB-25 Magnetometer

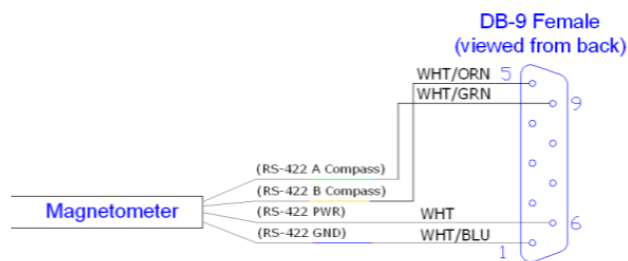

Magnetometer Alignment

You will need to perform a Magnetometer alignment after the system has been installed or any time the aircraft has had any major changes that could affect the magnetometer. The Magnetometer alignment will need to be performed in an area where you can easily rotate the aircraft. The alignment should be done with the engine stopped and the aircraft electronics on. You will need to be prepared to turn the plane and point the aircraft nose to Magnetic North.

You can access the Magnetometer alignment menu from the following buttons:

[EFIS] -> [SETTINGS] -> [AHRIS] -> [MAG ALIGN]

After accessing the MAG Align menu press the **[START]** button and follow the on screen directions.



Outside Air Temperature Transducer Installation

The OAT transducer P/N: 40305 is mounted on the airframe with a 3/8" hole where the exhaust will not affect it. We have found that the bottom of the wing works well. The OAT sensor wires should be connected from the EFIS Main Harness to the sensor with Fast On Terminals, Butt Connectors or with solder and heat shrink.

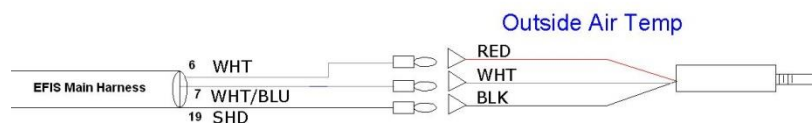

CAUTION Static Sensitive Part: Always ground yourself before wiring.

OAT Calibration

1. Place the AF-3400/3500 into Instrument Calibration mode. Use the **[NEXT]** button to scroll down to OAT and press **[SELECT]**.
2. Adjust the Shift Adjust value until the OAT is reading correctly.
3. Press **[SAVE]**

Alarm Output

The system has an output that will be connected to ground if one of the gauges is in the RED warning band or an input is configured to trigger the alarm. The Alarm Output can be used to drive a master warning light on the panel.

If multiple screens are used, only ONE screens alarm output is needs to be utilized. All EFIS and Engine alarms will be transferred to the main screen.

For wiring information see APPENDIX M:

Engine Sensor Installation

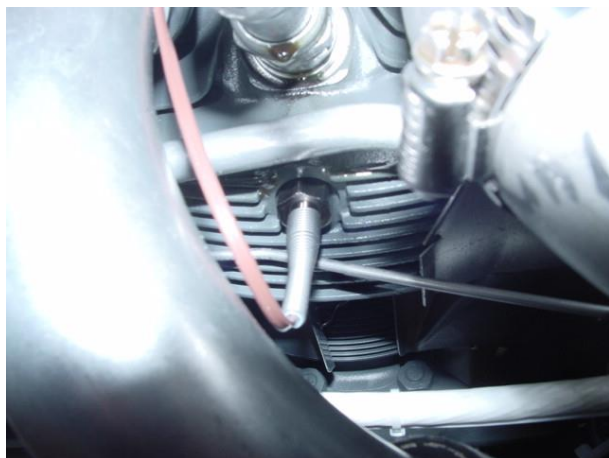

Lycoming CHT Probe Location



EGT Probe Location

EGT/CHT Installation

1. Locate the EGT probes, P/N 40200, not less than 1 1/2" or more than 3" below the exhaust stack attachment flange. 2" to 3" is optimum, and try to mount all probes equal distance from the exhaust flanges. On curved stacks, assume probe tip is on stack centerline for determining distance to exhaust flange. Carefully center punch the probe hole locations such that the portions of the probes external to the exhaust pipes will not interfere with any parts of the engine or cowling. Drill holes with a #30 drill.
2. Carefully insert probe and clamp snugly with screwdriver.
3. Install CHT probes, P/N 40100, in threaded wells on cylinders. Torque probe bodies to 25-30 inch pounds.
4. Install terminals on #20 type J & K thermocouple wire
5. **WIRES MUST HAVE A 1/4" DRIP LOOP TO PREVENT OIL OR SOLVENT FROM RUNNING INTO THE PROBE.**

This wire is very hard and will loosen inside a crimped brass or copper terminal, as there is no "cold welding" action like there is with crimped copper wire.

To prevent loosening of the crimp in service proceed as follows:

1. Strip wire exposing 3/8" of core conductor. Take care not to nick or cut the conductor.
2. Double end of wire back in hairpin bend so crimp is on doubled wire.
3. Crimp on a non-insulated barrel terminal using a crimping tool designed for non-insulated terminals. Be sure that the barrel seam is facing the rounded side of the crimping tool and not the crimping post as this will result in a poor crimp.
4. Place a drop of Alpha Metals 51022 liquid soldering flux (Ace Hardware) in open end of crimp and then heat and sweat in rosin core solder to fill the joint.

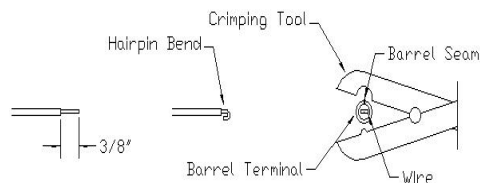

2. Fasten the extensions to the engine by means of clamps held by valve cover screws or by tying the extensions to intake tubes. If the extension goes up to a valve cover, provide some slack for a "drip loop" so that oil and engine cleaning solvents will drip off probe lead and not run into the end of the probe. It is important that the probe lead or extension wire be first clamped or tied to the engine before being tied to the engine mount or airframe, to keep "working" of the probe lead as it comes out of the body to a minimum. **AVOID CONTACT OF LEADS WITH CYLINDER HEADS OR EXHAUST PIPES. USE SLEEVING OVER LEADS IF TYING TO IGNITION HARNESS.** If leads cannot pass through firewall with other wiring, drill a 3/8" hole in firewall and use a neoprene grommet for each 4 to 6 leads, seal with a sealing compound.

JABIRU CHT Sensor

Jabiru engines require a 12mm ring-terminal CHT probe for each cylinder. First, slide the compression washer off the spark plug. Slide the 12mm ring-terminal probe onto the plug. Now, slide the spark plug compression washer back onto the spark plug. Reinstall the spark plug into the spark plug hole. Please refer to the documentation that came with your engine for more information.

Propeller RPM Sensor Installation

The RPM sensor should be installed in the **non-impulse** coupled magneto if possible (Engines with one electronic ignition should install the sensor in the impulse mag). The correct magneto can be found in the engine manual. The sensor is screwed into the magnet vent port nearest the magneto-mounting flange where the magneto attaches to the engine. Replace the existing vent plug with the sensor. The RPM sensor wires should be connected to the Engine Harness with Fast On Terminals, Butt Connectors or with solder and heat shrink. If you are using one mag and one electronic ignition you should use the mag sensor for your RPM input, as long as the mag is turning you will get displayed RPM even with the mag turned off.

The RED sensor is for Slick Mags and the BLUE sensor is for Bendix mags.

CAUTION: Do not route RPM sensor wires with Magneto P leads or electron ignition wiring. Most Magnetos have two ports on opposite sides, one near the plug wires and one near the drive shaft. The sensor needs to be mounted in the port closest to the drive shaft.

Pin 31	White/Orange	+5V	RED
Pin 32	White/Green	Signal	WHT
Pin 16	Back	Ground	BLM



ELECTRONIC IGNITION

The electronic ignition input is on connector pin 33. You will need to add a wire or using a pin extractor move the RPM wire from pin 32 to pin 33. ***This should only be used if you have dual electronic ignitions.***

Engine Harness Pin 33 Electronic Ignition input.

P-Mags

If using P-Mags you need to verify that they are in 12V RPM signal mode with the manufacturer and connect it to Pin 33 (Electronic RPM Input). If you have one P-Mag and one Mag you can use either the PMAG or the MAG sensor for your RPM input, **DO NOT CONNECT BOTH.**

Oil Temperature Sensor Installation

The oil temperature sensor is mounted on the engine. Your engine manual should show the proper location for the sensor. The bushing is supplied with a crush type gasket that can only be used once. The location is usually near the filter and should be safety wired to the engine case. Replace the existing vent plug with the supplied bushing and sensor. The Oil Temperature Pressure sensor wire should be connected from the harness to the transducer by crimping a standard #8 ring terminal to the wire.

Pin 7 White/Brown



Amp Transducer Installation

Shunt Transducer

Mount the Shunt amp transducer to a stationary location in the main power wire from the Alternator.

The Shunt Amp transducer wires should be connected from the harness to the transducer by crimping two standard #8 ring terminal to the wires.

Pin 24	Orange/Green	+	Alternator Side
Pin 25	Orange/Purple	-	Battery Side

Optional Hall Effect Transducer (Used for dual Alternator Systems)

Mount the amp transducer in the cabin area to a stationary location. The amp transducer board should be mounted so that the bottom of the circuit board does not touch any metal. The amp transducer is designed to measure the current in the wire from the alternator. The wire from the alternator must pass through the transducer in the proper direction; the board is marked alternator on one side and battery on the other. You will need to crimp the D-sub male pins to the transducer wires.

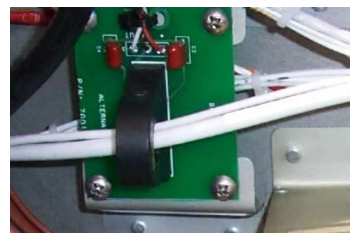

CAUTION: Always ground yourself before wiring.

Pin 29	+10V	White/Orange
Pin 11	Signal	White
Pin 30	Ground	White/Blue

Pressure Transducer Installation

Firewall Installation using Van's P/N: VA-168, 3-port manifold mounting block.

Oil Pressure Transducer Installation

Mount the oil pressure transducer in a stationary location. Connect the transducer with aircraft grade hose and fittings. You can find the proper oil pressure connecting port in your engine manual. **Your engine must have a pressure fitting with a restrictor hole in it.** The transducer is supplied with 1/8" NPT pipe thread connections. The case of the sender has to be connected to ground. The Oil Pressure transducer wire should be connected from the harness to the transducer by crimping a standard #8 ring terminal to the wire.



Pin 6 White/Yellow

NOTE: The pressure rating (100psi or 10bar 150psi) can be found stamped on the bottom hex fitting of the transducer

P/N	Pressure	Manufacturer	Color	Terminal
41,105	0-100 PSI	Stewart Warner	Gold	#8 Ring
41,115	0-150 PSI (10 bar)	VDO	Silver	#8 Ring

CAUTION: NEVER CONNECT THE PRESSURE TRANSDUCER DIRECTLY TO THE ENGINE.

Fuel Pressure Transducer Installation

Mount the fuel pressure transducer to a stationary location. Connect the transducer with aircraft grade hose and fittings. You can find the proper fuel pressure connecting port in your engine manual. **Your engine must have a pressure fitting with a .040" or smaller restrictor hole in it,** this prevents the fuel pump pulsations from damaging the transducer and will slow the flow of fuel if a hose were to fail. The transducer is supplied with 1/8" NPT pipe thread connections. The case of the sender has to be connected to ground. The Fuel Pressure transducer wire should be connected from the harness to the transducer by crimping a standard #8 ring terminal to the wire.

If you are using the P/N: 41,215 (0-30 PSI) transducer you will need to use a 1/4" Fast-On terminal for the transducer wire and a separate ground wire connected to the second terminal. It does not matter which terminal is used for the sensor wire or ground wire.

Pin 8 Brown

NOTE: The pressure rating can be found stamped on the bottom hex fitting of the transducer

Carbureted Engines

P/N	Pressure	Manufacturer	Color	Terminal
41205	0-16 PSI	Stewart Warner	Gold	#8 Ring
41215	0-30 PSI (2 bar)	VDO	Silver	1/4" Fast-On (Signal & GND)

Fuel Injected Engines

P/N	Pressure	Manufacturer	Color	Terminal
41305	0-60 PSI	Stewart Warner	Gold	#8 Ring
41315	0-80 PSI (5 bar)	VDO	Silver	#8 Ring

Fuel Flow Transducer Installation

The inlet and outlet ports in the fuel flow transducer have 1/4" NPT threads. Use only 1/4" NPT hose or pipe fittings to match. When assembling fittings into the inlet and outlet ports DO NOT EXCEED a torque of 180 inch lbs, or screw the fittings in more than 2 full turns past hand tight WHICHEVER HAPPENS FIRST. AFS will not be responsible for cracked castings caused by failure to use 1/4" NPT fittings, over-torquing the fittings, or assembling them beyond the specified depth. Use only aircraft FUEL LUBE on the NPT fittings; **NEVER USE TEFLON TAPE IN AN AIRCRAFT FUEL SYSTEM.**

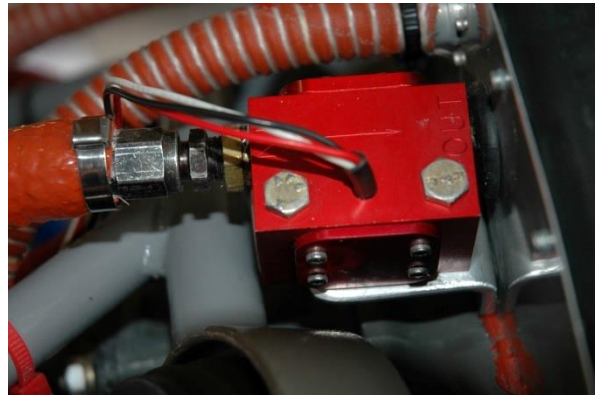

A screen or filter should be installed upstream of the flow transducer to screen out debris which could affect rotor movement or settle in the V-bearings.

Mount the fuel flow transducer in a position so the three wire leads are pointed straight up. Use only smooth radius curves in the fuel line and place the transducer with 5" of straight line before and after. The transducer wires should be connected directly to the 37-pin D-SUB using the cable provided. The transducer should be mounted according to the fuel metering device manufacturer's recommendations.

AFS has seen good results with the following mounting:

1. The transducer in a stationary location in-line between the electric boost pump and the engine driven pump.
2. The transducer in a stationary location in-line between the fuel injection servo and the distribution block.
3. The transducer in a stationary location in-line between the Engine driven pump and the Carburetor.

NOTE: The Electronics International FT-60 (Red Cube) transducer is rated for .6 – 70+ GPH. AFS recommends that the Electronics International FT-90 (Gold Cube) transducer be used for applications requiring more than 35 GPH (350HP) or for gravity flow fuel systems without a fuel pump (Contact AFS to exchange transducers).

CAUTION: NEVER CONNECT THE FUEL FLOW TRANSDUCER DIRECTLY TO THE ENGINE WITHOUT COVERING WITH FIRE SLEEVE.

The Fuel Flow transducer wires should be connected from the harness to the transducer using the supplied fast on connectors.

Pin 15	Red	+5V
Pin 14	White	Signal
Pin 13	Black	Ground

Manifold Pressure Transducer Installation

The manifold pressure transducer should be mounted on the firewall or in the cabin area. The transducer port is connected to the engine manifold pressure port with a 1/4" ID hose and hose clamp. The manifold pressure port location can be found in the engine manual.

P/N	Pressure	Application
41400	30 In-Hg	Normally Aspirated Engine
41401	59 In-Hg	Turbo Charged Engine

We used the following fittings to connect the transducer in our aircraft:

AN823-4 45 deg pipe to 37 deg flare fitting

471-4D 37 deg flare fitting for hose

306-4 1/4" ID Black Hose

The transducer wires should be connected from the harness to the transducer using the supplied Weatherpack connector.

For information on crimping the Weatherpack pins:

<http://www.weatherpack.com>

The *Weatherpack* connector comes with three pins, three rubber seals, and a connector housing. Slide the three rubber seals onto the three wires and the pins onto the ends of the wires. Crimp the 3 pins onto the ends of the wires, ensuring that the long tabs that cradle the rubber seal wrap around the seal.

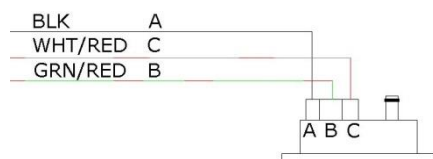
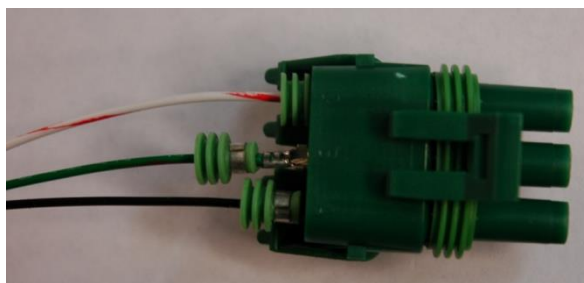

Fuel Tank Level Sensor

Float Type

Any standard 40-240 Ohm float style probe should work without any problem. The single wire from the Engine Harness should be connected to the float sensor terminal. You should verify that the float mounting base is attached to the airframe ground. For the tank gauges to work properly the floats should freely move from the top to the bottom of the tank.

Capacitance Type

If your system was setup at the factory for Capacitance fuel tanks inputs you can use any probe or adaptor that puts out a 0-5 Volt DC signal. You **MUST** place a 1.5K OHM resistor in series with the fuel tank input wire to limit the voltage to 4 Volts.

Trim & Flap Position Installation

The system is designed to read the position transducer that is in the MAC trim servo. The MAC servo has 5 wires. The two white wires are for motor operation and the color-stripped wires are for the position transducer.

The flap position can be measured by using the MAC linear position sensor P/N: POS-12

<http://www.rayallencompany.com/products/indsens.html>

CAUTION: DO NOT connect the MAC indicators and the AF-3400/3500 to the MAC trim servos. The MAC trim indicators are +12V and the AF-3400/3500 is +10V. The power and ground wires connect to all the servo's.

CAUTION: Verify before turning the system on that you have the trim servo wiring correct. If the +10V or Ground connection is wired to the WHT/GRN wire on a servo **you could damage the servo.**

Pin 2	Yellow	+10V	Trim and/or Flap WHT/BLU
Pin 3	Black	Ground	Trim and/or Flap WHT/ORN

Pin 34	Blue	Flap Posn	Flap WHT/GRN
Pin 35	Brown/Yellow	Elevator Posn	Trim WHT/GRN
Pin 36	Brown/Blue	Aileron Posn	Trim WHT/GRN
Pin 12	Not Pinned	Rudder Posn	Trim WHT/GRN

Note: Trim & Flap Positions MUST be calibrated. See the *Instrument Calibration* section.



Instrument Calibration

Instrument calibration will allow you to calibrate the various instruments and set the desired warning levels.

Calibration mode can be entered from the run screen as long as you do not have any airspeed from the following menu:

[CHECK] -> [MAINT] -> [ADMIN] -> [CALIB] *Hold for 2 seconds*

A list of instruments will appear. You scroll through the list by using the [PREV] and [NEXT] buttons. There are multiple pages of instruments.

To calibrate an instrument press the [SELECT] button while the cursor is on the desired instrument. On the Right of your screen a calibration list will appear.

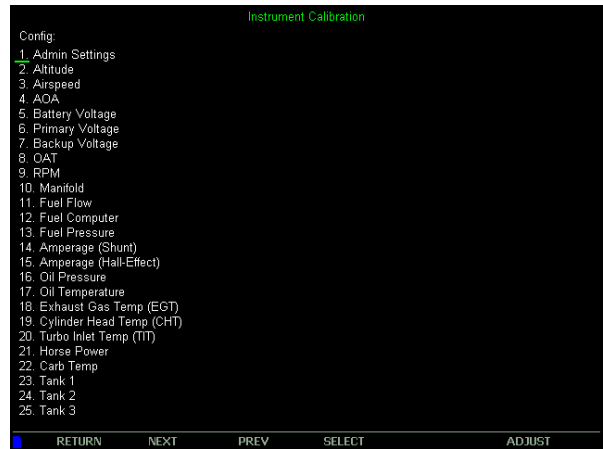

On the top right a number will appear. This is the digital value read by the sensor you are calibrating. This value will change if the condition the sensor is reading changes.

Below this number there will be a list of calibration data. Use [NEXT] and [PREV] buttons to scroll through the calibration list.

To adjust any of the warning values make sure the cursor is on the desired one and twist the knob until the value you desire is displayed.

When you have calibrated the instrument you can return to the main instrument list by pressing the [RETURN] button.

The following parameters can be set:

Max

The instrument displayed value at the top of the gauge

Red High At

The instrument displayed value when the needle turns red at the top of the gauge. You can set this parameter to the Max value if you do not want a top red band.

Yellow High At

The instrument displayed value when the needle turns yellow at the top of the gauge. You can set this parameter to the Max value if you do not want a top yellow band.

Yellow Low At

The instrument displayed value when the needle turns yellow at the bottom of the gauge. You can set this parameter to the Min value if you do not want a bottom yellow band.

Red Low At

The instrument displayed value when the needle turns red at the bottom of the gauge. You can set this parameter to the Min value if you do not want a bottom yellow band.

Minimum

The instrument displayed value at the bottom of the gauge

Audio On/Off

Turns on or off the audio warning feature.

Instrument On/Off

Turns on or off the entire instrument.

Calibration Tips:

- AF-3400/3500 systems are shipped with all sensors except Fuel Tanks and Trim / Flap sensors fully calibrated. Individual sensors should not need to be adjusted unless a new sensor is installed.
- The Amps transducer (Hall or Shunt) will need to have the zero current point set.
- Anytime you calibrate an Instrument and Enter the new data make sure to write that data down. You should keep a good record of this data with you at all time. That way if you accidentally set the default data you will have a record of what you have calibrated and will not have to do it again.
- When calibrating any temperature sensor wait until the calibration number stops changing (2-3 minutes) before recording it. This will help make the calibration more accurate.

To exit the calibration page press the **[RETURN]** button twice. This will return you to the usual startup. The calibration data you changed will be saved and used. Make sure to use caution while calibrating your instruments. Saving bad calibration data causes your instrument readings to be off.

Airspeed Color Range Settings

The Airspeed tape color range settings should be adjusted for your aircraft. All the speeds are in Knots.

Max: Top of the gauge Should be set to 240 KTS

Vne: Never Exceed Speed This is where the Red arc starts.

Vno: Normal Operation, This is the top of the green arc, bottom of the yellow.

Vfe: Flap Extend Speed, Top of the white arc.

Vs0: Stall Speed with the Flaps up.

Vs1: Stall Speed with the Flaps Down.

Airspeed Adjust: This should normally be 0, it can be used to offset the airspeed readings.

Airspeed Enable: This should normally be On, it can be used to turn off the airspeed gauge.

Units: Knots or MPH, the **Airspeed tape range V Speeds are always set in knots.**

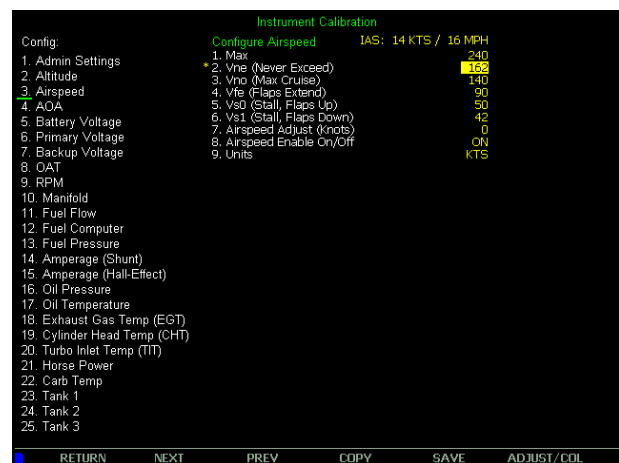

Instrument Calibration		
Config:	Configure Airspeed	IAS: 14 KTS / 16 MPH
1. Max		240
2. Vne (Never Exceed)		160
3. Vno (Max Cruise)		140
4. Vfe (Flaps Extend)		90
5. Vs0 (Stall, Flaps Up)		50
6. Vs1 (Stall, Flaps Down)		42
7. Airspeed Adjust (Knots)		0
8. Airspeed Enable On/Off		ON
9. Units		KTS
10. OAT		
11. RPM		
12. Manifold		
13. Fuel Flow		
14. Fuel Computer		
15. Fuel Pressure		
16. Amperage (Shunt)		
17. Amperage (Hall-Effect)		
18. Oil Pressure		
19. Oil Temperature		
20. Exhaust Gas Temp (EGT)		
21. Cylinder Head Temp (CHT)		
22. Turbo Inlet Temp (TIT)		
23. Horse Power		
24. Carb Temp		
25. Tank 1		
26. Tank 2		
27. Tank 3		

Altimeter Check

Item 2 in Instrument Calibration

The altimeter check should be performed on an as-needed basis. If the altimeter is found to be out of specification, the following adjustment can be performed from the EFIS Calibration menu:

2. Altitude

3. Altitude Adjust (FT)

After making an adjustment, ensure that the altimeter meets the tolerances allowed between 0 and 30,000 feet. If this adjustment does not correct the unit, contact Advanced Flight Systems Inc. for service.

RPM Calibration

Item 10 in Instrument Calibration

The RPM Gauge has three unique features that are slightly different than the standard gauge options. These features include:

Yellow Mid Band Top: Used to depict prop operating mid range restrictions. This should be set to 0 if your prop does not have any.

Yellow Mid Band Bottom: Used to depict prop operating mid range restrictions. This should be set to 0 if your prop does not have any.

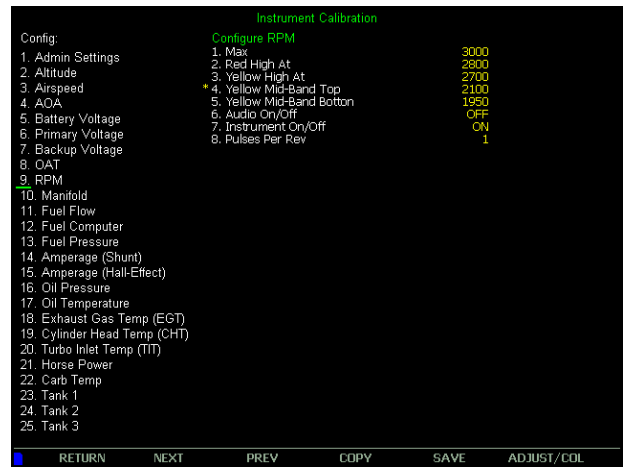

Pulses Per 2 Revolutions: The systems needs to know how many pulses the RPM input will see in two propeller rotations. The following data should help select the correct number to use.

- | | |
|--|------------|
| 1. Standard RPM sensor with Slick Mag 4 Cylinders: | Pulses = 2 |
| 2. Standard RPM sensor with Slick Mag 6 Cylinders: | Pulses = 3 |
| 3. Standard RPM sensor with Lasar Mag 4 Cylinders: | Pulses = 4 |
| 4. Standard RPM sensor with Lasar Mag 6 Cylinders: | Pulses = 6 |
| 5. Electronic Ignition 4 Cylinders: | Pulses = 4 |
| 6. Electronic Ignition 6 Cylinders: | Pulses = 6 |

Fuel Tank Calibration

Item 24-27 in Instrument Calibration

The AF-3400/350/4500 stores two sets of calibration numbers for each tank. The AF-3400/3500/4500 uses the ground calibration numbers when the Airspeed is less than 30kts (1700 RPM for Engine Monitor only). The flight calibration numbers are used when the airspeed is greater than 30kts (1700 RPM for Engine Monitor only). This feature enables the fuel gauges to read correct on the ground for a tail wheel equipped airplanes. If your plane does not have a tail wheel you should set the ground and flight data to the same calibration number.

Steps To Calibrate a Tank:

- Place the AF-3400/3500/4500 into Instrument Calibration mode. Use the [NEXT] button to scroll down to Tank 1 (Left Main), Tank 2 (Right Main), Tank 3 Left Aux, or Tank 4 Right Aux.
- Verify the Tank is Empty.
- Enter the max size of the Tank in the Tank Size field.
- Set the Audio On/Off Setting. If you set this to ON you will get an Audio warning if the fuel level is below the Red Low At setting.
- Set the Instrument On/Off Setting. If you set this to ON the tank will be displayed.
- Enter the number of calibration points; you must have at least two points. You could use four points (zero, 1/4, 1/2, 3/4, Full) or one point for every 2 gallons. Every calibration point must have a **Quantity that is higher than the previous one.**
- Use [NEXT] to Scroll down to the tank calibration data. The calibration data is displayed in two columns, one for ground and one for flight. Use the knob button to switch between ground and flight data columns. The current AD_VALUE reading for the tank is displayed at the top of the table.



8. Starting at 0 Gallons press the **[COPY]** button or use the knob to record the current AD_VALUE to the correct fuel amount and attitude (ground or flight).
9. Add fuel (at increments you've decided on) and then record the new AD_VALUE by pressing **[COPY]**
10. You will need to fill and record a reading for each attitude (ground and flight). If you have a tail wheel aircraft, the best way to do this is to record the ground data then lift the tail and record the flight data after the fuel reading has settled. Repeat this for each increment until the tank is full.
11. Press the **[SAVE]** button to save the data to permanent memory and **[RETURN]** to exit Tank Calibration.
12. After you complete Tank 1, move on to Tank 2 and follow the same procedure. If you have Aux Tanks, follow this procedure for Tank 3 & 4.
13. **IF YOU DO NOT HAVE AUX TANKS, TURN TANKS 3 & 4 OFF!**

CAUTION: Do not turn off power before pressing the save button and exiting the calibration menu.

Calibration Tips:

When lifting the tail you should set it on something, so the level you lift it to will be consistent. You should also wait until the reading stops changing before setting it.

Fuel tank sensors are not accurate when the tank is near full. Once you notice the reading not changing much or not corresponding with the rest of the readings during calibration the last few entries in the fuel calibration data should be set to the same value.

If the tanks do not consistently show full you should lower the digital value for the tank full data.

The fuel gauge will only show the digital fuel amount for the highest reading that the float changed with a plus sign indicating that the correct fuel amount is not known but is over the last reading. The analog gauge will show full for the last changing reading. It is normal for an 18-gallon tank to show 16+ when it is full. This indicates that the float stopped changing at 16 gallons and this is the highest fuel reading that can be detected by the float in the tank.

Trim/Flap Calibration

Item 28-30 in Instrument Calibration

From the Calibration menu select:

Item 26 Elevator

Item 27 Aileron

Item 28 Flap Position

The calibration menu lets you set the up, down, and center position. If you don't have one or any of these indications, you can turn them off.

To calibrate Elevator Trim (for example):

1. Run your trim servo all the way up. With UP highlighted, press **[COPY]**.
2. Move your trim servo to the center streamline position. With CENTER highlighted, press **[COPY]**.
3. Move your trim servo all the way down. With DOWN highlighted, press **[COPY]**.
4. Press **[SAVE]**.

Repeat this procedure for Aileron Trim and Flap Position

CAUTION: Do not turn off power before pressing the save button and exiting the calibration menu.

Test Audio

Item 33 in Instrument Calibration

The range is (0%-100%) and is adjusted using the knob followed by pressing the **[SAVE]** button. The Test Audio menu will play all the sounds in the system.

Switch Inputs

Item 34 in Instrument Calibration

The system has 3 hardware inputs that can be used to monitor an external switch. The inputs are labeled #1, #2, #3

Input #3 is normally used for an AOA Flap Switch.

For wiring information see APPENDIX M:

The Inputs will display the text on the Screen from the SYSTEM.AFD file when an Input is either grounded or open. A normally open or normally closed switch is selectable in the Inputs menu, see example below. There is also a timer feature that will alarm after a set time is reached. If any input other than FUEL TANK XFR is selected, the timer will zero after the input is disabled. In the case of a FUEL TANK XFR input, the timer will only clear after a power cycle. This allows the pilot to have the total duration of the fuel tank transfer for the entire flight (to allow for multiple tank transfers).

Note: FUEL TANK XFR can **only** be used on INPUT #1 or #2

EXAMPLE

Input #1 should Alarm with "Door"

From the EFIS Calibration menu select:

34. Inputs

1. Input 1 Label [**Press KNOB**] several times until cursor is on first letter.
[**Turn KNOB**] until "D" appears (Capital and smaller case letters are available)
[**Press KNOB**] [**Turn KNOB**] until "o" and so on...use the space character to delete remaining characters
[**SAVE**]

EXAMPLE

Input #1 is a Normally Closed switch, meaning EFIS will alarm when switch is not grounded

34. Inputs

3. Input 1 Logic [**Turn KNOB**]

EXAMPLE

Input #1 should alarm if tip tank transfer pump is left on for 25 minutes

34. Inputs

2. Input 1 Usage [**Turn KNOB**] until TANK TRANSFER appears press
4. Input 1 Timeout (mm:ss) [**Turn KNOB**] until 25:00 appears

CAUTION: Do not turn off power before pressing the save button and exiting the calibration menu.

NOTE: If you do not want any Input text on the screen you should use a space in the label field.

You may have to **reboot** AF-3000 unit before settings take effect.

Administrative Settings

System Files

The system has the following files in flash memory.

Calibration data files for the sensors:

AIRDATA.AFC	Airspeed, Altimeter, AOA, System Voltages
ENGINE.AFC	Engine Sensors
EGTCHT.AFC	EGT and CHT Sensors
HORSEPWER.AFC	Engine Horse Power Parameters
TANKS.AFC	Calibration data for all fuel tanks
AOA.AFC	Calibration data for AOA

Instrument range settings data files:

(max, min, red, yellow, green arcs)

AIRDATA.AFD	Airspeed, Altimeter, System Voltages
ENGINE.AFD	Engine gauges

Checklists & Maintenance data files:

CHKLST.AFD	Check Lists
MAINT.AFD	Maintenance items

System settings data files:

NVRAM.AFD	Backup of NV Ram
SYSTEM.AFD	System Network, Hardware Installed
EFIS.AFD	EFIS screen system settings

Data Logging files:

yymmddhhm.ALD	Flight and Engine data logs
yymmddhhm.ALS	System debug logs
yymmddhhm.ALX	Ram memory logs

y	year
mm	month
dd	date
hh	hour
m	minute

Multiple Screen Setup

Multiple screens (EFIS and Engine Monitor) can be connected together to enable data sharing by using a standard Ethernet cross over cable or Ethernet hub plugged into the back of the units. Once the screens are connected with the cable you will need to configure each screen for transmit and receive in the calibration menu.

Every screen on the Network must have a unique IP Number, we use the following format for multiple screens:

EFIS Screen in front of Pilot

15. Network IP Number this screen 175

Screen on CoPilot side

15. Network IP Number this screen 176

Screen #3 - MFD

15. Network IP Number this screen 177

The **16. Network IP Number Other screen setting** controls which other screen the EFIS data will be displayed from. Any screen that does not have an AHRS should have this set to the address of the remote screen with the AHRS that it will display EFIS data from or compare AHRS data with.

Dual AHRS Configuration



CAUTION

For Dual AHRS cross checking to work you should always set the **AHRS Module Config** to TXD and the **Network IP Number Other screen** to the address of the remote AHRS.

Multiple Screen Configuration Examples

The following examples should help you configure your system:

<Example #1> AF-3500EF EFIS and AF-3500EM Engine Monitor

AF-3000/4000EF EFIS Screen #1

1. Admin Settings
12. Engine Module Config HW:OFF, NET:RXD
13. Air Module Config HW:INT, NET:TXD
14. AHRS Module Config HW:INT, NET:TXD
15. Network IP Number this screen 175
16. Network IP Number Other screen 176

AF-3000/4000EM Engine Monitor Screen #2

1. Admin Settings
12. Engine Module Config HW:INT, NET:TXD
13. Air Module Config HW:OFF, NET:RXD
14. AHRS Module Config HW:OFF, NET:RXD
15. Network IP Number this screen 176
16. Network IP Number Other screen 175

<Example #2> AF-3500EF EFIS and AF-3500EE EFIS-Engine Monitor (AHRS Cross Checking)

AF-3000/4000EF EFIS Screen #1

1. Admin Settings
12. Engine Module Config HW:OFF, NET:RXD
13. Air Module Config HW:INT, NET:TXD
14. AHRS Module Config HW:INT, NET:TXD
15. Network IP Number this screen 175
16. Network IP Number Other screen 176

AF-3000/4000EE EFIS-Engine Monitor Screen #2

1. Admin Settings
12. Engine Module Config HW:INT, NET:TXD
13. Air Module Config HW:INT, NET:OFF
14. AHRS Module Config HW:INT, NET:TXD
15. Network IP Number this screen 176
16. Network IP Number Other screen 175

AF-3000/4000EF EFIS Screen #1

- 1. Admin Settings
 - 12. Engine Module Config HW:OFF, NET:RXD
 - 13. Air Module Config HW:INT, NET:TXD
 - 14. AHRS Module Config HW:INT, NET:TXD
 - 15. Network IP Number this screen 175
 - 16. Network IP Number Other screen 176

AF-3000/4000EE EFIS-Engine Monitor Screen #2

- 1. Admin Settings
 - 12. Engine Module Config HW:INT, NET:TXD
 - 13. Air Module Config HW:INT, NET:OFF
 - 14. AHRS Module Config HW:INT, NET:TXD
 - 15. Network IP Number this screen 176
 - 16. Network IP Number Other screen 175

AF-3000/4000MFD Screen #3

- 1. Admin Settings
 - 12. Engine Module Config HW:OFF, NET:RXD
 - 13. Air Module Config HW:OFF, NET:RXD
 - 14. AHRS Module Config HW:OFF, NET:RXD
 - 15. Network IP Number this screen 177
 - 16. Network IP Number Other screen 176

Dual Screen Data Configuration

Any time engine or EFIS settings are changed you should transfer the files to both screens. One screen can get some of the configuration files from the neighboring screen in the Admin Menu. If **both screens** are on the Admin Page in the EFIS Calibration menu, select:

14. Request Remote Files

This will force the screen to get the configuration data files from the remote screen for those items that this screen is setup to receive and will reboot with the new files.

If the screen is setup to receive **Air Module Data** the following files will be transferred:

[AIRDATA.AFD](#) Airspeed, Altimeter, System Voltages
[AOA.AFC](#) AOA Calibration

If the screen is setup to receive **Engine Data** the following files will be transferred:

[ENGINE.AFD](#) Engine Gauges
[TANKS.AFC](#) Engine Gauges

Note: This works on non-S CPU units only. Units with the s-CPU must have the files transferred manually through Calibration Menu -> Admin Settings -> Transfer Files To/From SD Card

APPENDIX A: Specifications

Physical

AF-3400

Weight: 4.6 Lbs
Panel Cutout: 6" x 5.55"
Mounting: (Qty 4) 6-32" Screws

AF-3500 or AF-4500p Panel Mount

Weight: 4.8 Lbs
Panel Cutout: 7.5" x 6.656"
Mounting: (Qty 4) 6-32" Screws

AF-4500

Weight: 6.0 Lbs
Panel Cutout: 8.31" x 7.26"
Mounting: (Qty 2) Socket Screw (7/64 Allen Wrench)

Power Requirements

10 to 16 VDC (10 to 30 VDC S/N 61350+)

2 Amps

For a dual screen system both screens will need a power connection on each **EFIS Main Connector**.

EFIS Main Connector

Pin 1 Primary Power Master Power input for the screen
Pin 15 Backup Power Alternate Power input for the screen

NOTE: Both power inputs can be displayed on the EFIS or Engine Monitor Screen.

SD Card

The AF-3400/3500/4500 has a standard size **Secure Digital (SD)** memory card slot in the upper left hand corner for : Software Loading, Data Transfer, and Map Databases. Do not use SD memory cards that are over 2 Gigabytes in size.

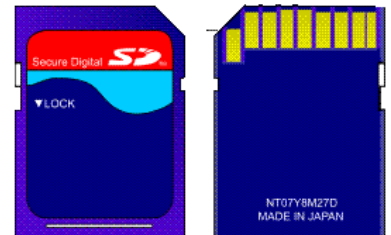

AF-3400/AF-3500 Non-S Clock Battery

The internal clock battery of Non-S processor displays should be replaced every 5 years.

P/N: 71702 Lithium Battery 12.5 x 2.5mm BR1225

Backup Battery

The internal backup battery life should be check at annual and replaced when needed.

P/N: 717200 Lithium Battery 7.4V 2.2 Ah

THIS PAGE INTENTIONALLY LEFT BLANK

APPENDIX B: Hardware Specifications

AF-3400 Mounting

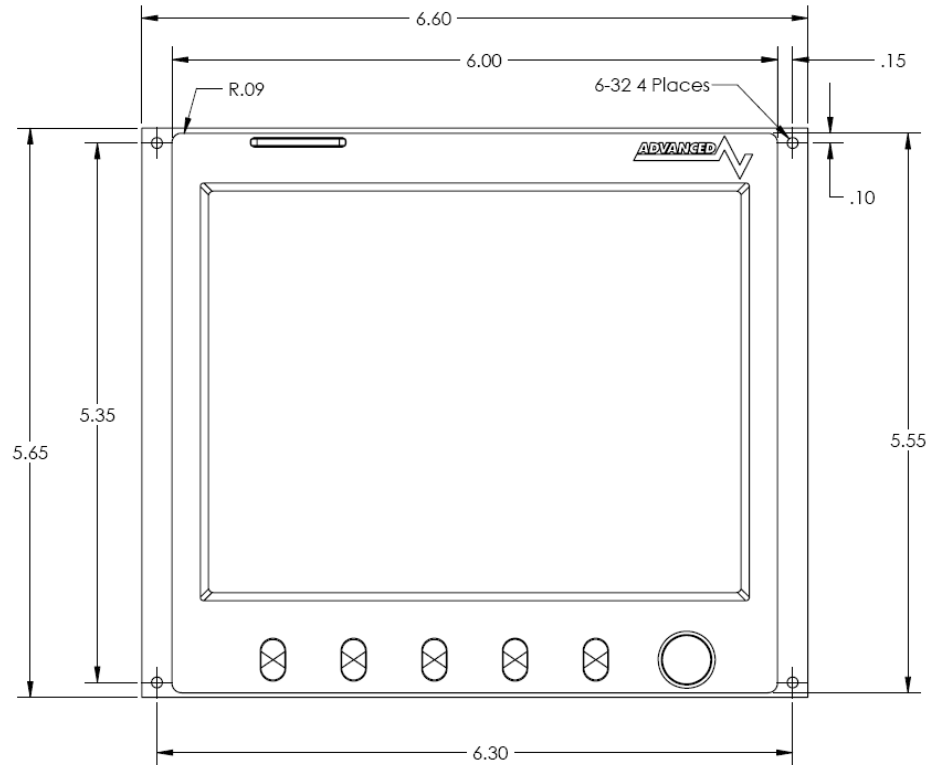

AF-3500 and AF-4500p Mounting

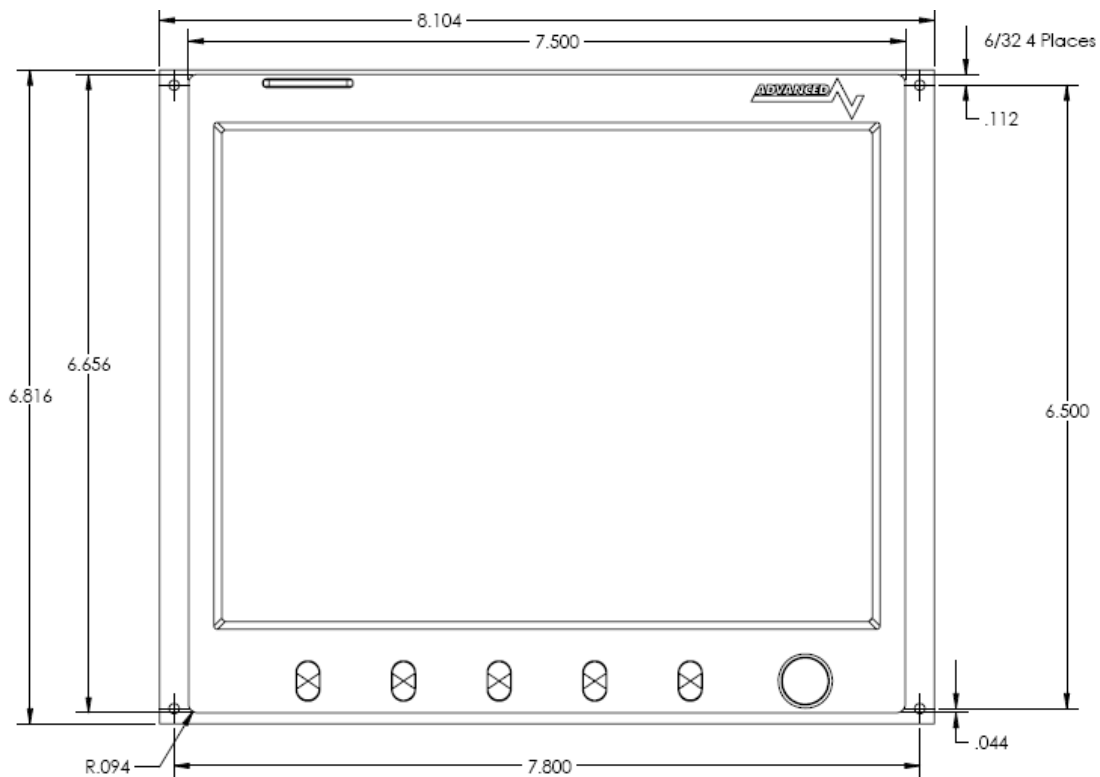

AF-3500 Rear View Drawing



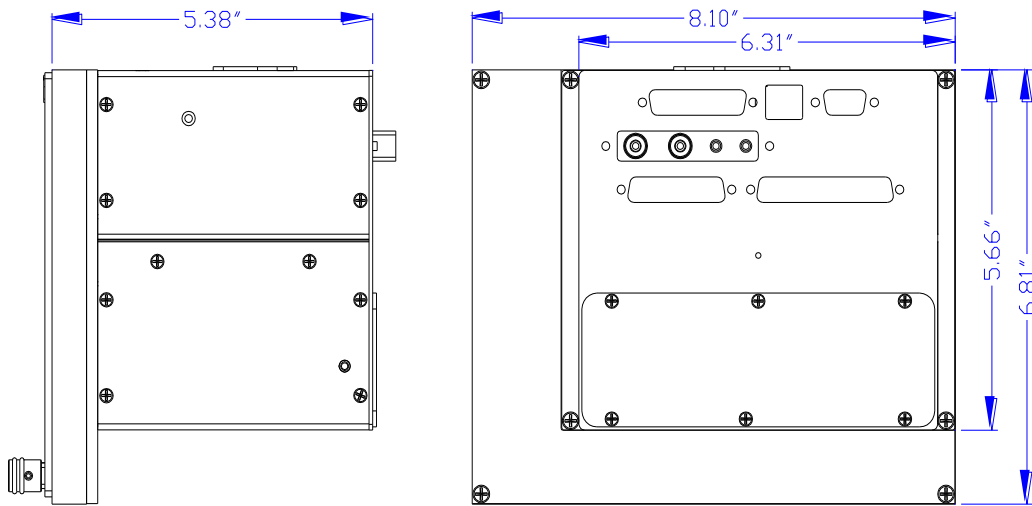
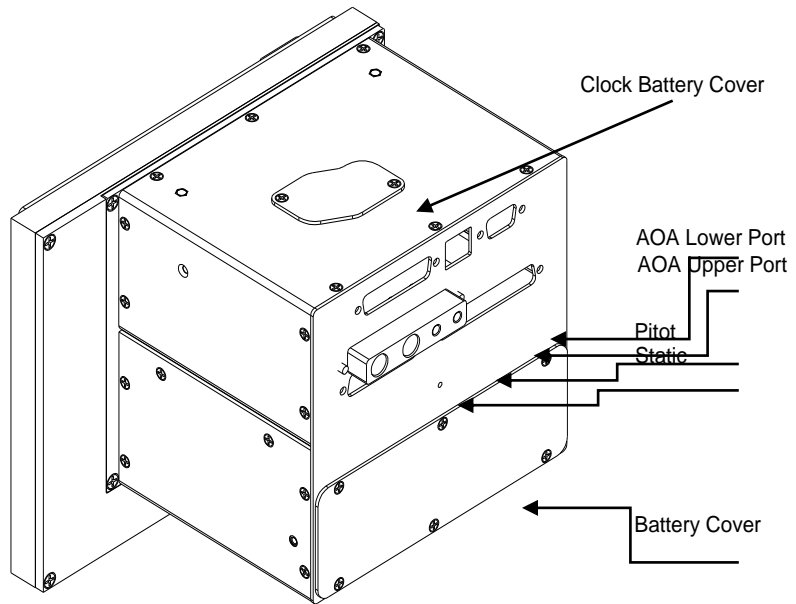

AF-4500s Tray Mounting & ARINC Adapter

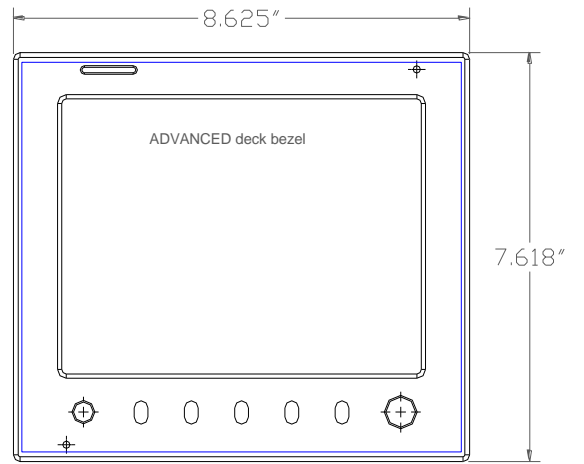
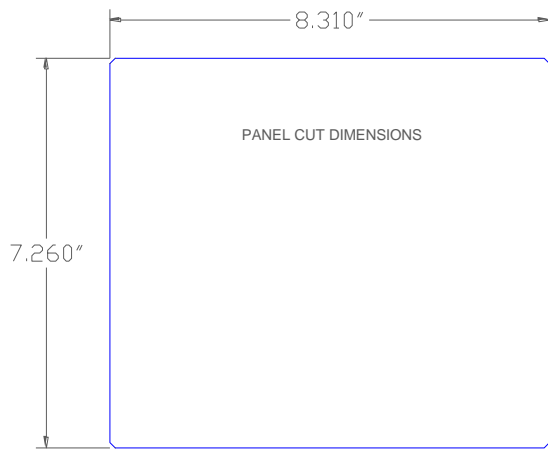

TRAY SIDE VIEW

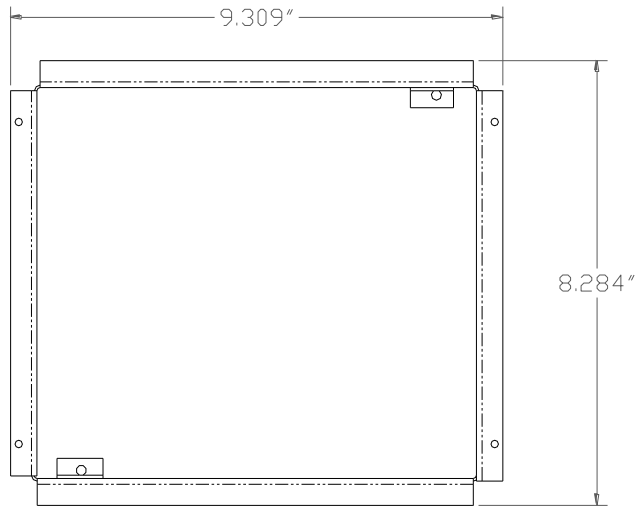

TRAY FRONT VIEW

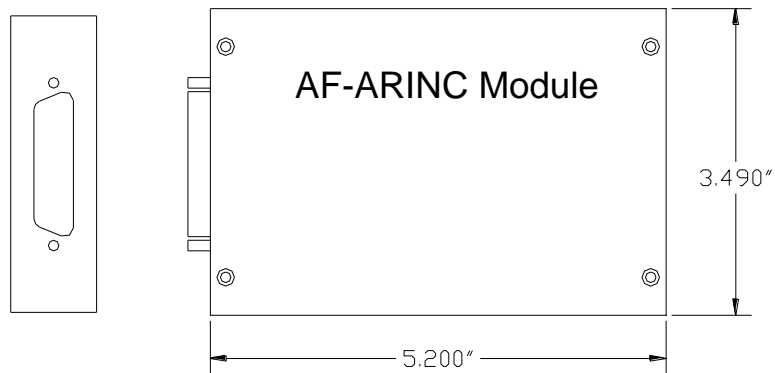
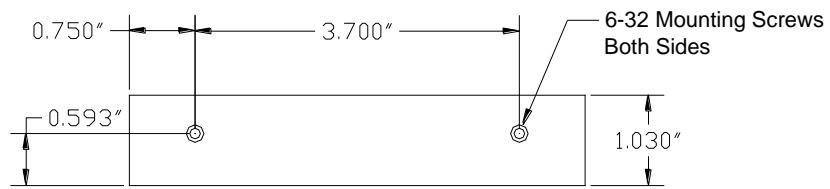

EFIS MAIN CONNECTOR

Pin	Pin Name	I/O
1	MASTER POWER	IN
2	RESERVED	--
3	MASTER GROUND	IN
4	SERIAL #3 - TX	OUT
5	SERIAL #3 - RX	IN
6	OAT +	OUT
7	OAT SIGNAL	IN
8	INPUT #3	IN
9	SERIAL #1 - GROUND	IN
10	SERIAL #1 - TX	OUT
11	RS-422 - B COMPASS	OUT
12	RS-422 - POWER	OUT
13	SERIAL #2 - TX	OUT
14	WARNING LIGHT	OUT
15	BACKUP POWER	IN
16	AUDIO GROUND	OUT
17	INPUT #1	IN
18	EFIS AUDIO	OUT
19	OAT GROUND	OUT
20	INPUT #2	IN
21	SERIAL #2/#3 - GROUND	OUT
22	SERIAL #1 - RX	IN
23	RS-422 - A COMPASS	OUT
24	RS-422 - GROUND	OUT
25	SERIAL #2 - RX	IN

EFIS EXPANSION CONNECTOR

Pin	Pin Name	I/O
1	SERIAL #4 - TX	OUT
2	SERIAL #4 - GROUND	OUT
3	RESERVED	--
4	RESERVED	--
5	GROUND	OUT
6	SERIAL #4 - RX	IN
7	RESERVED	--
8	RESERVED	--
9	+5V DC (350mA max)	OUT

ELECTRICAL CONNECTIONS

ENGINE SENSOR CONNECTOR

Pin	Pin Name	I/O
1	RESERVED	--
2	TRIM POWER	OUT
3	TRIM GROUND	OUT
4	CARB TEMP	IN
5	CARB GROUND	OUT
6	OIL PSI	IN
7	OIL TEMP	IN
8	FUEL PSI	IN
9	TIT #2 -	OUT
10	TIT #2 +	IN
11	AMPS #2 - SENSOR	IN
12	RESERVED	--
13	FUEL FLOW - GROUND	OUT
14	FUEL FLOW - SENSOR	IN
15	FUEL FLOW - POWER	OUT
16	RPM - GROUND	OUT
17	MANIFOLD - GROUND	OUT
18	MANIFOLD - VOLTAGE	OUT
19	SENSOR 5V	OUT
20	TANK #1	IN
21	TANK #2	IN
22	TANK #3	IN
23	TANK #4	IN
24	AMPS #1 - VOLTAGE	OUT
25	AMPS #1 - GROUND	OUT
26	MANIFOLD - SENSOR	IN
27	TIT #1 -	OUT
28	TIT #1 +	IN
29	AMPS #2 - POWER	OUT
30	AMPS - GROUND	OUT
31	RPM - VOLTAGE	OUT
32	RPM - SENSOR	IN
33	ELECTRONIC RPM - SENSOR	IN
34	FLAP POSITION	IN
35	ELEVATOR TRIM	IN
36	AILERON TRIM	IN
37	RESERVED	--

EGT/CHT PROBE CONNECTOR

Pin	Pin Name	I/O
1	RESERVED	--
2	CHT 6 -	OUT
3	EGT 6 -	OUT
4	CHT 5 -	OUT
5	EGT 5 -	OUT
6	CHT 4 -	OUT
7	EGT 4 -	OUT
8	CHT 3 -	OUT
9	EGT 3 -	OUT
10	CHT 2 -	OUT
11	EGT 2 -	OUT
12	CHT 1 -	OUT
13	EGT 1 -	OUT
14	CHT 6 +	IN
15	EGT 6 +	IN
16	CHT 5 +	IN
17	EGT 5 +	IN
18	CHT 4 +	IN
19	EGT 4 +	IN
20	CHT 3 +	IN
21	EGT 3 +	IN
22	CHT 2 +	IN
23	EGT 2 +	IN
24	CHT 1 +	IN
25	EGT 1 +	IN

APPENDIX D: Metric Units

Each gauge has Display Units or Units in Calibration that can be changed to display alternate units.

EXAMPLE

Oil Temperature

Boot the EFIS in Calibration mode and select:

18. Oil Temperature

9. Display Units [TURN KNOB] [SAVE]

CAUTION: Do not turn off power before pressing the save button and exiting the calibration menu.

OAT units can be changed on the main screen from the [EFIS] [Settings] or [ENGINE] menu by selecting the [OAT C/F] button.



Available Units

Altitude

FEET/INHG
METER/INHG
FEET/MBAR
METER/MBAR

Airspeed

KTS
MPH

Temperatures (EGT, CHT, TIT, Carb, Coolant, Oil, OAT)

Fahrenheit
Celsius

Manifold

InHg
MBAR

Fuel Flow, Fuel Computer, Fuel Tanks

Liters
Gallons

Fuel Pressure, Oil Pressure

PSI
MBAR

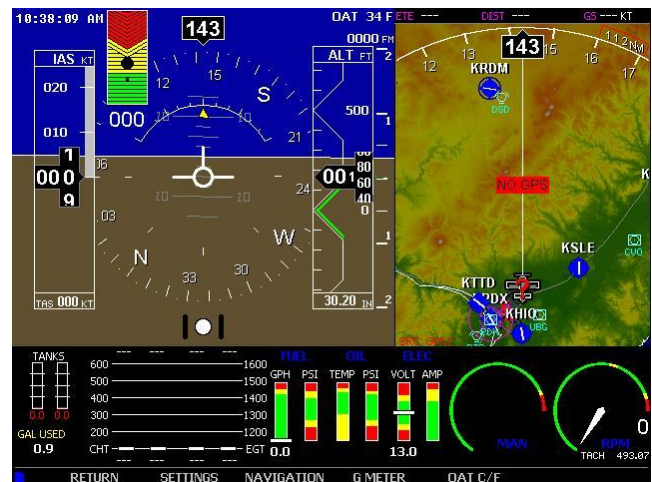

APPENDIX E: Software Updates

PROCEDURE

1. Format the SD card with your PC. Select the FAT 32 option in the format window. Format is typically a right-mouse-click option in the Windows File Explorer. See picture below. Be sure to select the SD card and not any other drive on your computer. Formatting will erase all data from the selected drive.
2. Download the latest version of software file onto the SD Card:
<http://www.advanced-flight-systems.com>
3. Insert the SD data card into the slot on the AF-3000 unit.
4. Power on unit with Master Power **not Internal Battery**.
5. Remove the card after the system has installed the new software, 2 to 3 minutes.
6. Verify that your ARINC adaptor does not require updated software using the software install notes.

CAUTION: If the SD data card is left in the system with the new software file, it will install software every time power is turned on.

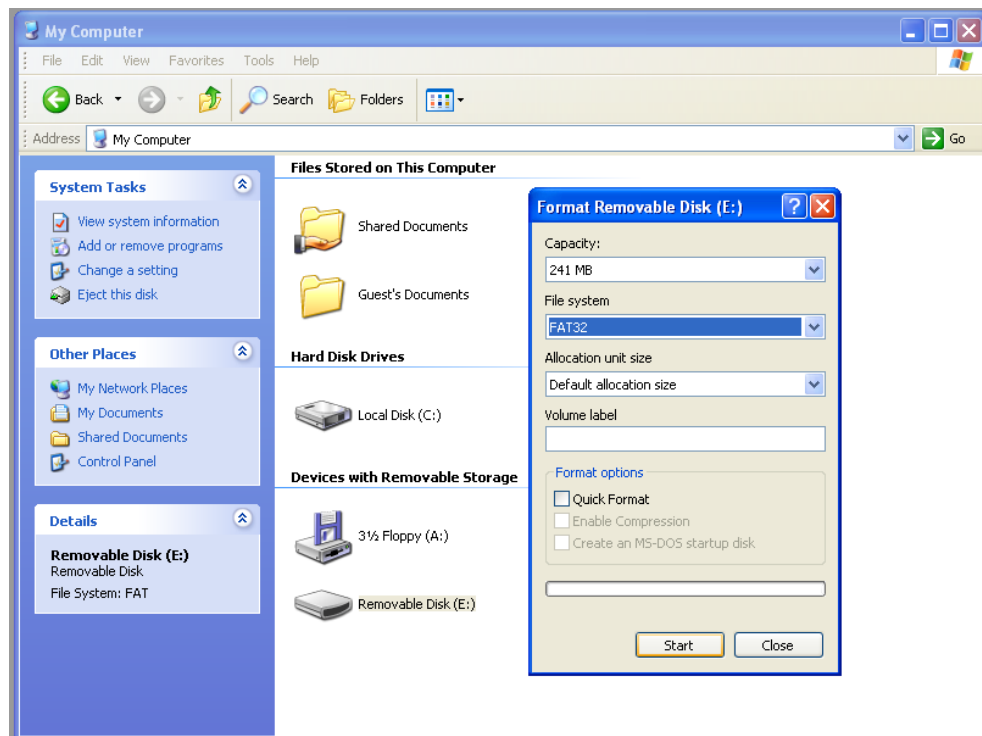

APPENDIX F: EFIS Activation Keys



The following optional features are enabled by entering a unique activation key:

Item	Description
1. Mapping	AFS Moving Map Pages
2. AOA	Angle of Attack display
3. SVN	Synthetic Vision

PROCEDURE

The activation keys can be entered from the following Calibration Menu:

1. Admin Settings
 21. System Maintenance
 1. Manage Keys

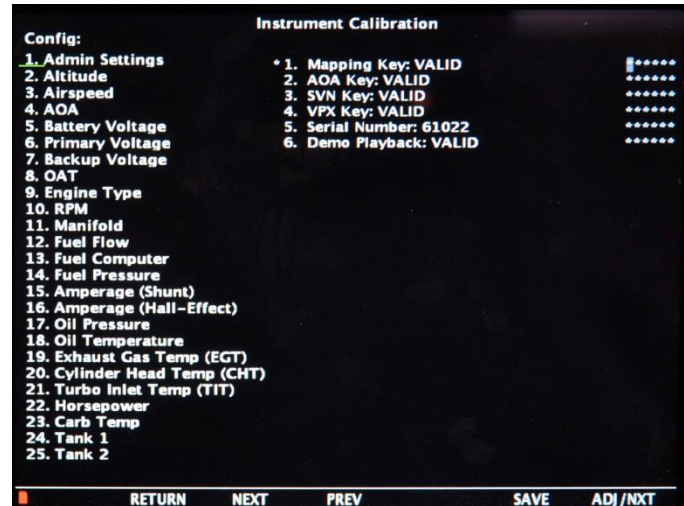

1. Use the NEXT and PREV buttons to move the cursor to the desired item.
2. Turn the knob to select the number to enter.
3. Press the knob to move the cursor to the next digit
4. Press the save button once the complete key has been entered.

Once a valid key has been entered the optional feature will display **VALID**.



Each EFIS screen will have a unique activation key for each feature purchased. If you have multiple screens verify that you are entering the correct key for the correct Serial Number EFIS screen.

APPENDIX G: Aerosance FADEC Interface



The Engine Monitor can be configured to display engine data from an Aerosance SBC FADEC control unit with a RS-232 data connection connected to EFIS Serial Port #3

Wiring Connections:

<u>Aerosance SBC</u>	<u>Function</u>	<u>EFIS Main Cable</u>
TXD	Serial Port #3 RXD	Pin 5
GND Serial	Serial Port #3 GND	Pin 21

Administration Settings:

The following must be set for the engine data to be displayed:

1. Serial Port #number Function set to **FADEC SBC 100**
2. 15. Engine Module Config set to **HW:EXT, NET:TXD**



APPENDIX H: Eagle EMS Interface



The engine monitor can be configured to display engine data from an Eagle EMS Electronic Ignition. The Eagle EMS and AFS Engine Monitor share CHT, RPM, Fuel Flow, Fuel Pressure, and Manifold Pressure.

Below is the method of getting the data from the EagleEMS to your AFS Engine Monitor.

CHT - EagleEMS recommends a splitter made by JPI

RPM - Install a 1K ohm resistor between the RPM output of the EagleEMS (wired to Pin 32 of the AFS Engine Monitor) and Pin 31 of the AFS Engine Monitor

Fuel Flow - Install a 1K ohm resistor between the Fuel Flow output of the EagleEMS (wired to Pin 14 of the AFS Engine Monitor) and Pin 15 of the AFS Engine Monitor. Set K-Factor to 330

Fuel Pressure - Install the fuel transducer for the AFS Engine Monitor in the standard location (on the 3-port manifold provided by Van's). EagleEMS gets fuel pressure from a different location on the engine.

Manifold Pressure - 'T' into the manifold pressure hose coming out of the engine fitting going to the EagleEMS.

APPENDIX I: AOA Pressure Port Location

AIRCRAFT	WING SPAN LOCATION	WING CHORD LOCATION	FLAP SWITCH
AirTractor 802A on Wipline 1000 floats	Left wing bay just outboard of the tie down	20" aft of the leading edge at 25% chord	Contacts closed at all but flaps up
Glasair II	Upper port 25 1/4" and lower port 27 1/4" inboard of the outboard wing rib	Just aft of the main spar 13 1/4" aft of the leading edge	During flap extension closed prior to 1/3 flaps
Glastar	Just inboard of the most outboard wing rib	Just aft of the main spar 11 inches aft of the leading edge	During flap extension closed prior to 1/3 flaps
Lake LA4-200	Upper port 7" and lower port 5" inboard of the outboard wing skin	8" aft of the leading edge. See drawing S-LA4.	Closed when flaps down
Lancair Legacy	Ports are pre-installed	ports are pre-installed	During flap extension closed prior to 1/3 flaps
Lancair 250/320/360	Upper port 2" inboard of the most outboard wing rib. Lower port just inboard of the most outboard rib.	"D" section just forward of the electrical conduit. 3 1/4" aft of the leading edge (12% chord)	During flap extension closed prior to 1/3 flaps
Lancair ES	Upper port 3" inboard of BL202.5 rib inboard face. Lower port 1.5" inboard of BL202.5 inboard face	9" aft of the leading edge along the cord line right wing	During flap extension closed prior to 1/3 flaps
Lancair IV with winglets	Inboard winglet right wing	7.5" aft of the leading edge	During flap extension closed prior to 1/3 flaps
Lancair IV w/o winglets	Pitot tube dry bay opposite wing	15 to 40% chord	During flap extension closed prior to 1/3 flaps
Murphy Moose	Middle of the outboard wing bay. Upper port 6" and lower port 4" inboard of the wing skin outer end	2 1/2" forward of the wing skin break at the spar	During flap extension closed prior to 1/3 flaps
RV-4, 6, 7, 8	Middle of the outboard wing bay. Upper port 4 3/4" and lower port 7 1/2" inboard of the wing skin outer end	6" forward of the wing skin break at the spar about 12" aft of the leading edge	During flap extension closed prior to 1/3 flaps
RV-9	Middle of the outboard wing bay. Upper port 4 3/4" and lower port 7 1/2" inboard of the wing skin outer end	11" aft of the leading edge measured along the chord line	During flap extension closed prior to 1/3 flaps
RV-10	Middle of the outboard wing bay. Upper port 9 1/4" and lower port 7 1/4" inboard of the wing skin outer end	9" forward of the wing skin break at the spar	During flap extension closed prior to 1/3 flaps

APPENDIX J: Troubleshooting

Problem	Cause	Solution
The EFIS does not power on	The EFIS is not getting power	Check circuit breakers, wire connections, and that the connector is seated properly.
The EFIS does not power off	The EFIS remains on	Verify engine RPM < 1500, verify main and backup power has been removed. Press and hold button 2 for > 5 seconds
Fuel Tank/Trim Indications are wrong	Fuel/Trim sensors have not been calibrated	Calibrate fuel tanks and trim per installation manual.
Engine/GPS information is not showing up on second unit	Ethernet cable not installed or incorrect settings	Ensure Ethernet cable is connected to both screens and IP Addresses are set correctly.
Dashes shown in CRS or BRG information on CDI	No CRS/BRG source is selected	Change NAV source settings EFIS -> NAVIGATION -> SRC
NO GPS shown on MAP	Unit cannot detect a GPS connected	Serial port function, of GPS/NAV Source not set correctly or GPS powered off
GPS INT shown on MAP	GPS has not acquired a position lock	Ensure GPS antenna has an unobstructed view of the sky
MAP FILE TO OLD shown on MAP	SD Card contains older map file	Download the newest map data files from the AFS website
Charts are not displaying	Charts haven't been downloaded or aren't located on the card correctly	Charts should all be located on the SD Card in a folder named CHARTS. Airport selected is not in downloaded region
Garmin GNS-430W/530W not communicating with EFIS	EFIS or GNS-430/530 not configured properly	See 430W/530W - EFIS - Autopilot - ARINC Interface Troubleshooting Document
AFS PILOT does not stay in EXT mode	Autopilot is not receiving adequate ARINC data	See 430W/530W - EFIS - Autopilot - ARINC Interface Troubleshooting Document
AFS PILOT oscillates laterally	EFIS or AP gains set incorrectly	-Ensure current software installed -Set the GPSS gain in the AP to 16 -Adjust the AP LAT Activity while the AP is flying the aircraft (not in EFIS mode). The aircraft should be responsive to changes in track using the AP knob. -Adjust the EFIS Roll gain so the aircraft will make a 90+ degree turn and overshoot the final heading by 1 degree or less
Software update doesn't work	Improperly formatted SD card or wrong brand SD Card	Ensure a SanDisk brand SD Card is used and it is formatted with a FAT32 file system.
Fuel Computer Warning continues to flash yellow	Improperly set fuel computer setting	Due to wing dihedral, different aircraft require a different <u>Cross Check Error Limit</u> for the fuel computer to compare fuel qty and fuel flow. Change the setting to approx 15.0 in the Fuel Computer item in Instrument Calibration

GNS-430W/530W - EFIS - Autopilot - ARINC Interface Troubleshooting



These tests must be done on the screen that is directly wired to the AF-ARINC module and 430W RS-232 Aviation format serial port.

1. Verify that the EFIS is communicating with the AF-ARINC module

- a. Verify the ARINC software version from the following EFIS menu: [CHECK] -> [MAINT.] -> (ABOUT)

If the EFIS is displaying an ARINC Version number, the EFIS is communicating with the ARINC module and you can move to Step 2.

- b. Verify the EFIS serial port settings from the calibration menu: [CHECK] -> [MAINT.] -> [ADMIN] -> [CALIB.]

1. Admin Settings

Verify that you have the same serial port number configured to **ARINC** that you physically wired the module to. This is normally Serial Port #4, although it does not have to be.

- c. Verify that the AF-ARINC module does not have old software.

From the Calibration menu select:

- 1. Admin Settings
 - 21. System Maintenance
 - 3. Upgrade ARINC Software

Cycle the power to the ARINC module (Turn OFF and ON Master Switch) to see if the EFIS can detect the module at the slower speed. If the EFIS detects the AF-ARINC module you will need to insert an SD card with the updated ARINC software to program it.

- d. Verify that you have power to the AF-ARINC module.

Remove the top AF-ARINC cover by removing the four top cover screws. If the Green LED is lighted then the module has power. If the LED is not lighted use a volt meter to verify that the AF-ARINC DB-25 connector has power.

- Pin 1 (12-28) Volts
- Pin 3 Ground

If the connector has power and you have not wired the connector backwards! Call AFS for a replacement AF-ARINC module.

- e. Verify that you have wired the serial port TXD and RXD to the correct pins on both the EFIS and ARINC connectors.

EFIS AUX DB-9	Color	ARINC DB-25
1	WHT/ORN	22
6	WHT	10

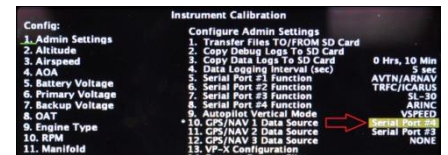
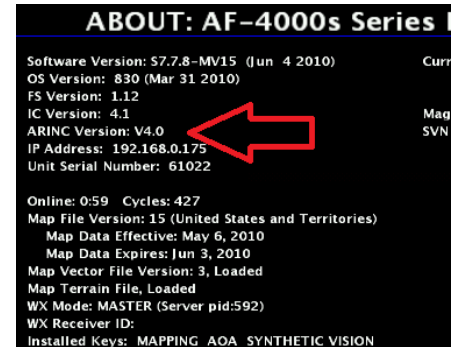

2. Verify that the 430W Configuration is correct

AF-3000 AF-4000 Manual V 7.6



a. Main ARINC 429 CONFIG

Power up the 430W while holding the ENTER button and press [ENT] -> [ENT] to get to the Main ARINC 429 Config page. Verify that the screen looks correct.

b. Serial Ports

Turn the inside right knob to configure the MAIN RS232 CONFIG to the following settings

Note: Serial port selections shown are specific to the AFS schematic found in the rear of this manual.



c. VOR/LOC/GS ARINC 429 CONFIG

Turn the inside right knob around 14 clicks to configure the VOR/LOC/GS ARINC 429 to the following settings.



3. Verify that the 430W GPS ARINC to EFIS interface is working

The 430W must be running software version 3.30 or later or you will not get a CDI needle displayed!

- a. Verify that the 430W is selected as the EFIS NAV source from the following menu: EFIS -> NAVIGATION -> CRS/GNAV1

The course needle should be set to CRS/GNAV1

- b. Turn on the 430W and select the Instrument Test Page, second startup page (press ENTER once after power up).

Verify that the 430W is not in VLOC mode for this test. The 430W will power up in the last mode selected.



Verify that the EFIS CDI, VDI, and WPID all look like this screen:

WPID: GARMN
 CDI Half Left
 VDI Half Up

If the CDI, VDI, and WP ID are correct move to Step 4.



If the WP ID is missing check the following:

- 1. Verify that you have configured the Serial Ports and GPS/NAV data sources correctly. **You should not have a GPS/NAV data source connected to Serial Port #1, it should only connect to the ARINC module!**

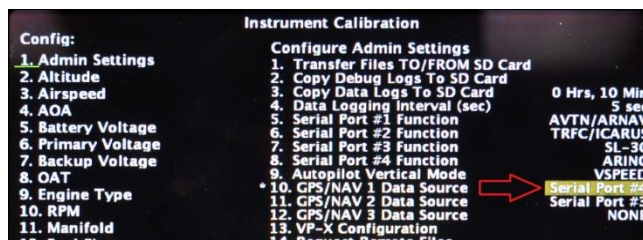

If you have the following it will not work !!

12. GPS/NAV 3 Data Source Serial Port #1

2. Verify the EFIS Serial Port #1 connections, Check the following connections:

EFIS DB-25	Function	Wire	430W
10	Serial #1 TXD	WHT	4001-57
22	Serial #1 RXD	WHT/ORN	4001-56

If the CDI and VDI are missing the AF-ARINC module is not receiving ARINC data from the 430W. Check the following connections:

ARINC DB-25	Function	430W
12	ARINC GPS In 2-A	4001-46
24	ARINC GPS In 2-B	4001-47

4. Verify that the EFIS can send CRS/OBS data to 430W CRS

a. Select <-CRS-> on the EFIS knob.

As you turn the EFIS knob the OBS number on the 430W Test Page should change. Once you stop turning the knob the OBS setting will return to 150.



If the OBS did not change on the 430W the 430W is not receiving ARINC data from the AF-ARINC module. Check the following connections:

ARINC DB-25	Function	430W
25	ARINC Out B	4001-49
13	ARINC Out A	4001-48

5. Verify that the 430W NAV ARINC to EFIS interface is working

- Press the ENTER button on the 430W to bypass the Instrument Panel Self Test.
- Press the CDI button on the 430W to switch to NAV mode.



- c. Verify that the EFIS CRS needle turned green and is displaying the nav frequency from the 430W.

If the CDI did not turn green the AF-ARINC module is not receiving ARINC NAV data from the 430W. Check the following connections:

ARINC DB-25	Function	430W
23	ARINC ILS/VOR 1-B	4006-23
11	ARINC ILS/VOR 1-A	4006-24



The ILS/VOR ARINC signals are not on the same 430W connector as the GPS signals! They are wired to the 430W 4006 connector.

6. Verify that the EFIS can send commands to the Autopilot

- a. Select the following Menu on the EFIS screen:
EFIS -> AP/FD
- b. Select the Heading Bug for the Lateral mode: LAT HDG
- c. Select the Altitude Bug for the Vertical mode: VER ALT
- d. If the Flight Director is turned on it should have yellow wings and tips.
- e. Select <-HDG-> from the knob list, center the heading bug .
- f. Press the **EFIS** button on the Autopilot and verify that the AP display changes to "EFIS" or "EXT.".



If the AP display did not change to EFIS it is not getting ARINC steering signals from the AF-ARINC module. Check the following:

- i. Verify that the AP/FD LAT and VER sources are set correct; LAT **HDG** VER **ALT**
- ii. If you have installed an AUTOPILOT Source Select switch is it in EFIS mode?

- iii. Check the following connections:

AF-ARINC	DB-25 Function	Autopilot DB-25
25	ARINC Out B	15
13	ARINC Out A	14

- g. Verify that the AP will follow the heading Bug, as you turn the heading bug left and right on the EFIS screen the control stick should follow it.

If the control stick did not follow the heading bug check steps i. and ii. from above.

7. EFIS and Autopilot Gain Settings

The following settings are what we use in our RV-10 & RV-4 and should be used as a good starting point for your aircraft.

EFIS -> AP/FD -> SETTINGS

EFIS Settings

	<u>RV-10</u>	<u>RV-4</u>	<u>Sportsman</u>
Roll Gain	0.05	0.05	0.04
Loc Gain	0.50	0.50	0.50
Alt Gain	5.00	5.00	3.00
GS Gain	3.00	3.00	3.00
FD Gain	1.50	1.50	1.20

To change autopilot settings, press the following buttons.

LAT: Press AP button for a few seconds

VERT: Press EFIS button for a few seconds

AP Settings

	<u>RV-10</u>	<u>RV-4</u>	<u>Sportsman</u>
LAT Activity	9	5	3
LAT Torque	12	12	12
Bank Angle	High	High	Med
Micro Activity	0	0	0
GPSS Gain	16	16	16
VRT Activity	6	3	11
VRT Torque	12	12	12
MIN Speed	80	65	70
MAX Speed	170	170	145
Static Lag	2	2	1
Micro Activity	0	0	2
Half Step	N	N	N

APPENDIX K: Vertical Power VP-X/PRO Interface

The 's' processor units are capable of interfacing to a Vertical Power VP-X/PRO electronic circuit breaker unit. When enabled, the Vertical Power Status page can be accessed by pressing the CHECK button on the EFIS screen (Pressing CHECK again brings up the Checklist).

The first few pieces of information are regarding general electrical system status.

STATUS: Online/Offline
 WIGWAG: Online/Offline
 CURRENT: Total system current draw
 PRI VOLTS: Voltage of primary bus
 AUX VOLTS: Voltage of aux bus

The NAME, CURRENT, BREAKER, & STAT labels reference whichever breaker is highlighted below.

Breakers are colored based on their fault status:
 Green - OK
 Gray - Not connected
 Red - Tripped



VP-X Setup

Serial Port Connection - The VP-X/PRO can be wired to any of the 4 EFIS Serial Ports.

Set the SERIAL PORT FUNCTION to **VP-X**.

Line 36 of Instrument Calibration allows for programming the VP-X/PRO.

1. VP-X OFF/ON - Turns the VP-X interface ON or OFF.

Each circuit breaker can then be programmed by rotating the knob to change the character and pressing the knob to advance characters.

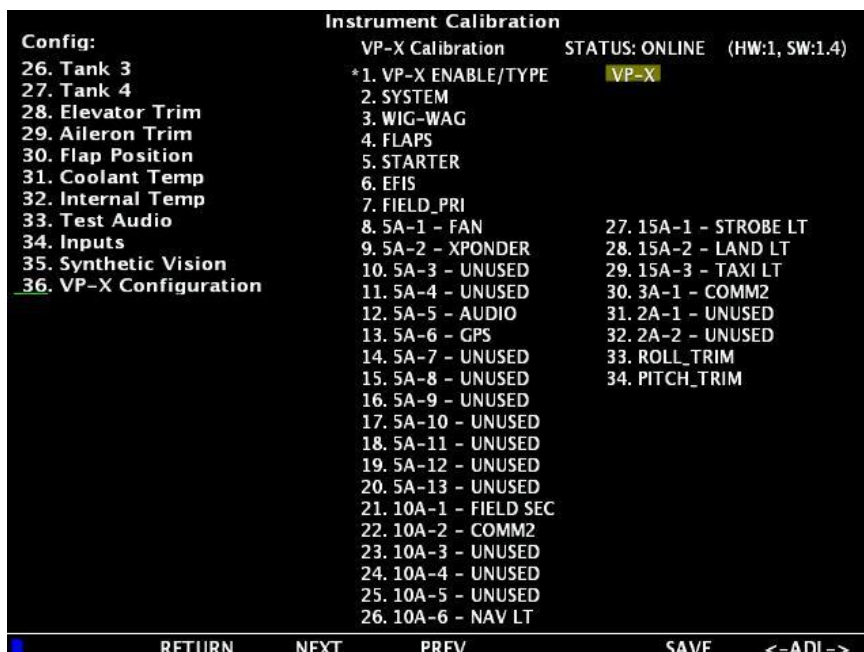

APPENDIX L: Flight Director/AF-Pilot Procedures flying an Approach

Flying an LPV Approach

The following example shows how to use the EFIS, Garmin 430W and ADVANCED Pilot to fly the KUAO GPS 35 approach.

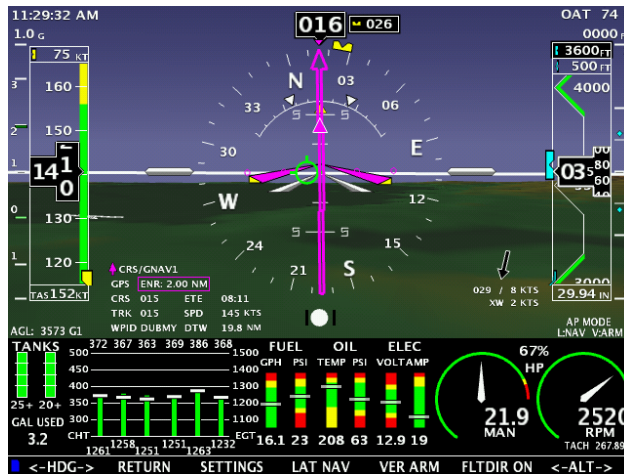

In this picture we have selected the RNAV GPS 35 approach on the 430W, selected DUBMY as our Initial Approach Fix, and activated the approach in the 430W. The AF/FD mode is NAV for Lateral and ARM for Vertical. This means the AP/FD is following the 430W's lateral GPS course and is holding altitude at the altitude bug until vertical guidance is provided from the 430W (usually just outside the FAF).

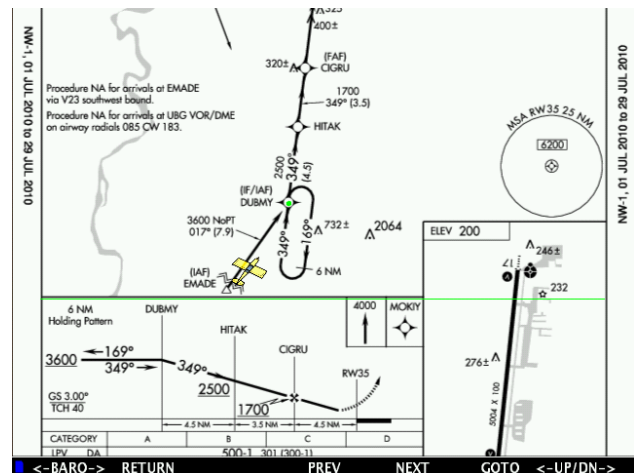

We are currently 2:01 Minutes and 4.6 miles from DUBMY (IAF). From the map screen we have selected CHART, selected the RNAV 35 approach plate, and then used the knob to scroll the approach plate. The map screen will remember the current plate and scroll position making it very easy to switch back and forth from the map screen to the approach plate. From the approach plate we see that we need to be at 3600Ft at DUBMY and we have set the altitude bug to 3600 ft. Again, the AP/FD mode is NAV for lateral and ARM for vertical, the AP/FD is following the 430W flight plan for lateral and using the altitude bug for vertical.



From the approach plate we see that we now need to be at 2500ft at HITAK and we have set the altitude bug to 2500 ft. The AP/FD vertical is still in ARM waiting for vertical guidance from the 430W.

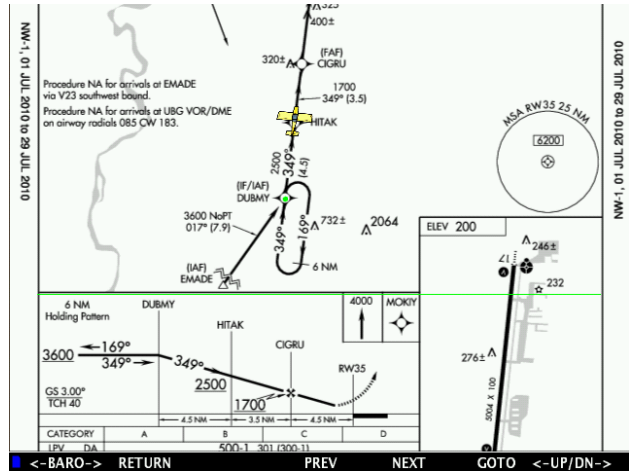

After passing HITAK we start getting vertical guidance from the 430W and it switches from Vertical ARM to Vertical NAV. At this point the AP/FD will hold altitude until the vertical deviation indicator is centered. Once the VDI is centered, the AP/FD will capture the glide-slope and hold it centered while descending.

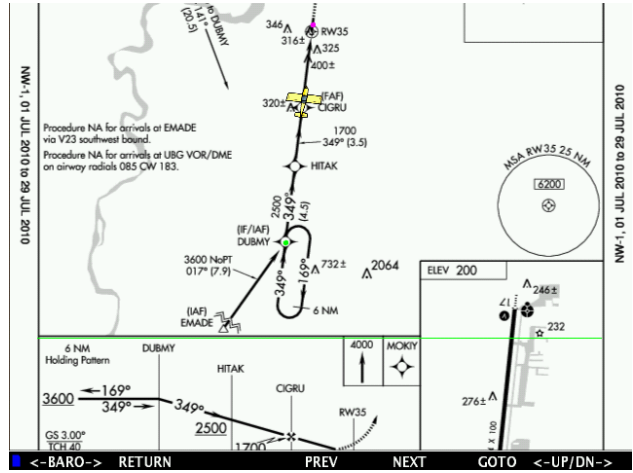

At CIGRU (the FAF) the VDI changes from a pointer to a diamond indicating that we are getting the Glide Path Indicator (GPI) and are on the "LPV Glide-slope". I have also set the Minimums Bug to the 500Ft Decision Height from the approach plate.

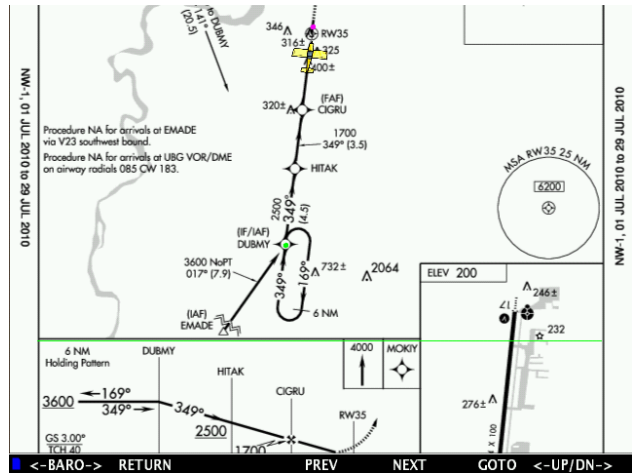

At 200ft above the decision height, the flight director tips will turn orange indicating the AP/FD is about to level off and hold altitude at the Minimums Bug. Notice in this picture that the green flight path marker is on the runway indicating the path of the aircraft.

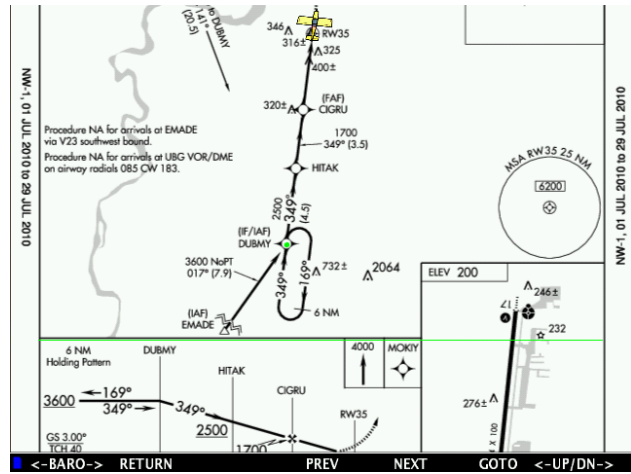

Before reaching the decision height I have set the Altitude bug to the 4000ft missed procedure altitude from the approach plate. After pressing the SUSP button on the 430W the AP/FD will follow the 430W missed procedure for lateral guidance and switch from following the Minimums bug to the Altitude bug.

Flying an ILS Approach



For the AP to capture and follow the ILS, the following procedure should be used.

1. ILS frequency active and verified in your Nav radio (110.90 in this example)
2. ILS inbound Approach Course (OBS) set using the CRS knob selection (218 in this example)
3. AP LAT mode in ARM
4. AP VER mode in ARM
5. Heading bug must be within +/- 40 deg of the Inbound Approach Course
6. Altitude bug must be below the glide-slope intercept altitude.
7. LOC CDI must be within 80% and you must be below the GS for the VER mode to change to NAV.

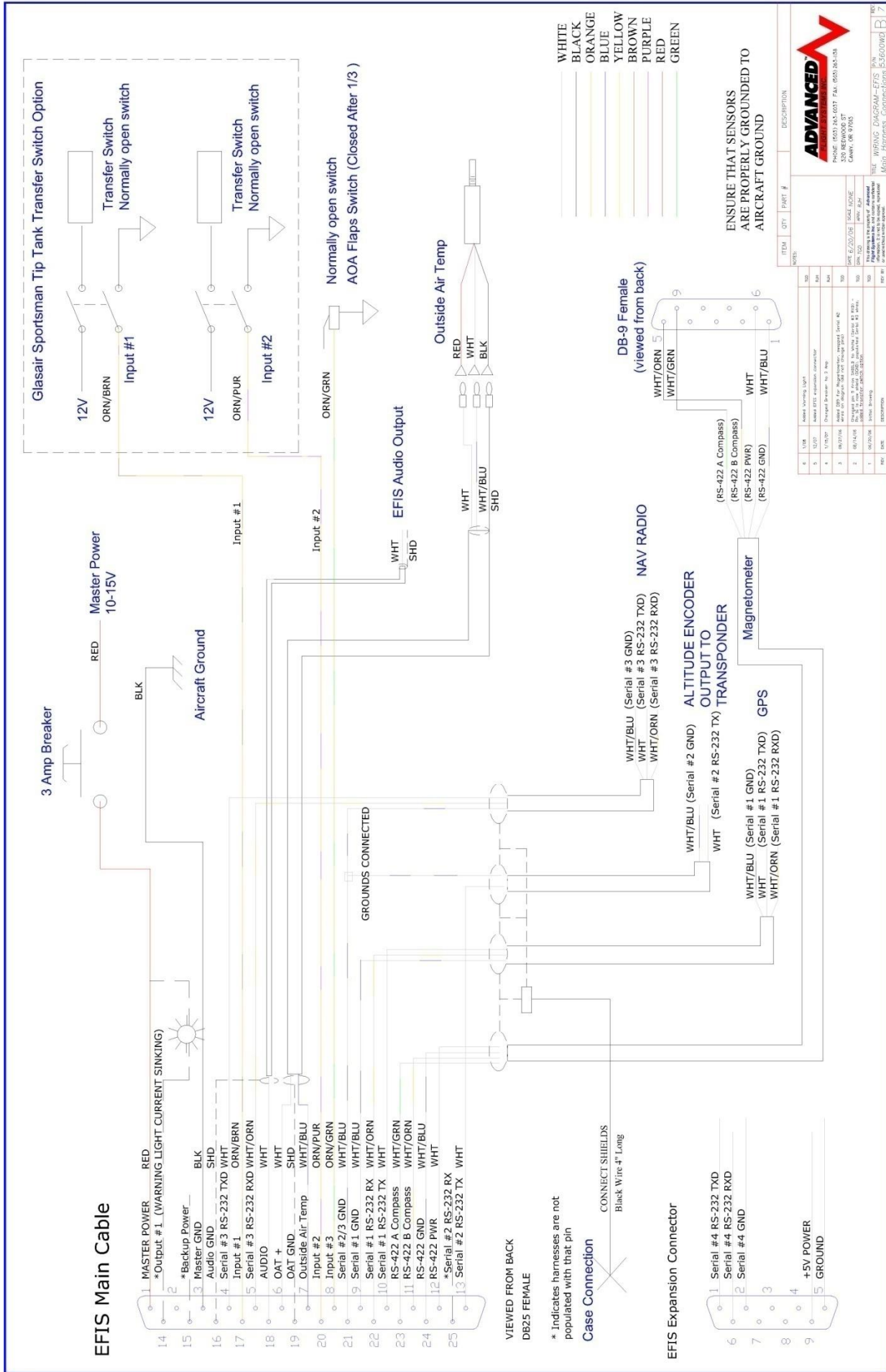

Engine Monitor Main Harness

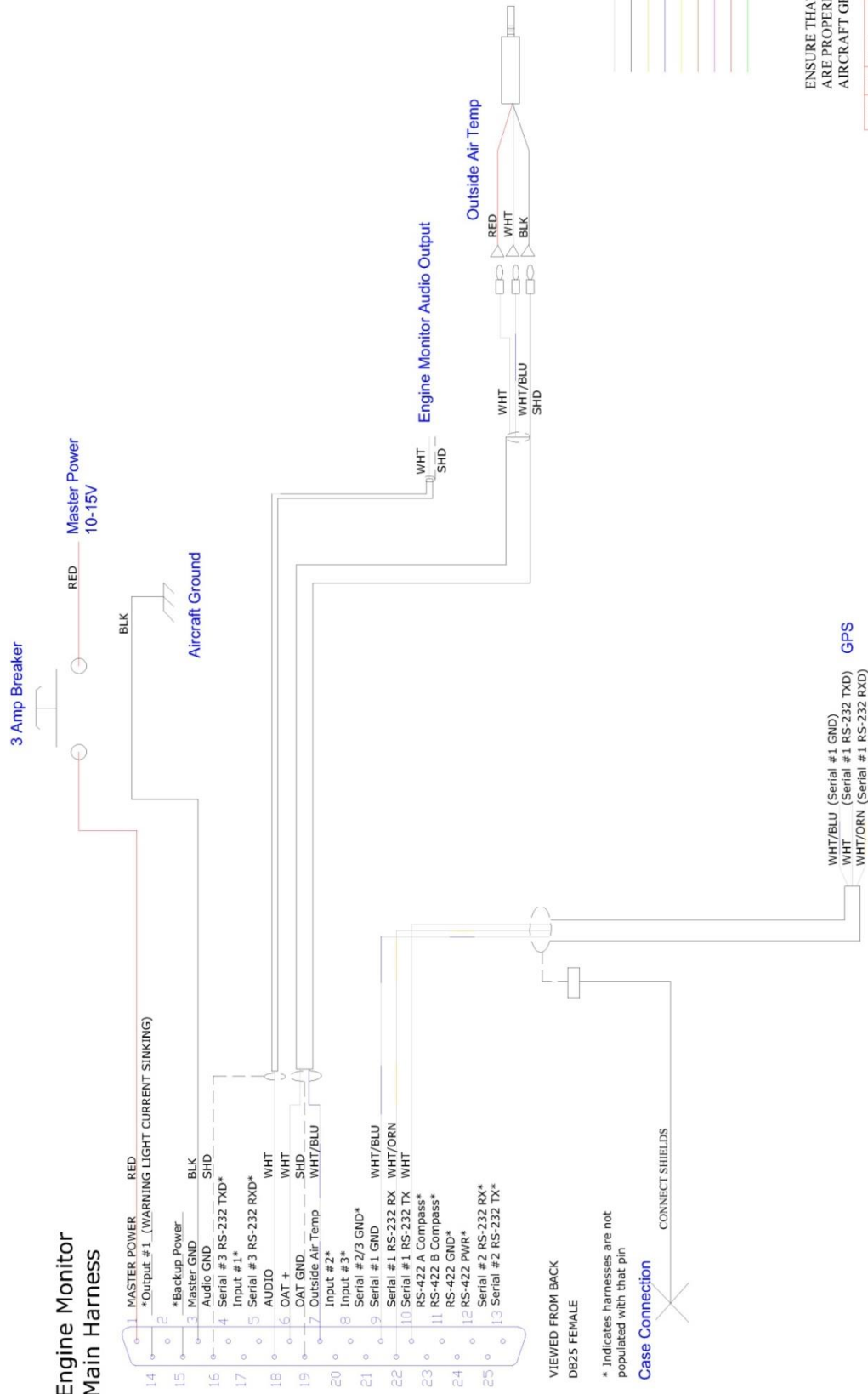

VIEWED FROM BACK
DB25 FEMALE

* Indicates harnesses are not populated with that pin

Case Connection

CONNECT SHIELDS

- WHITE
- BLACK
- ORANGE
- BLUE
- YELLOW
- BROWN
- PURPLE
- RED
- GREEN

ENSURE THAT SENSORS ARE PROPERLY GROUNDED TO AIRCRAFT GROUND

ITEM	QTY	PART #	DESCRIPTION
NOTES			
DATE 11/20/07 SCALE NONE			
DRAWN BY: [Signature]			
CHECKED BY: [Signature]			
APPROVED BY: [Signature]			
PHONE (503) 263-0537 FAX (503) 263-1038			
WWW.ADVANCEDAVIATION.COM			
CANYON, OR 97003			
THE WIRING DIAGRAM—			
Engine Main Harness			
P/N 535 (000) 1			



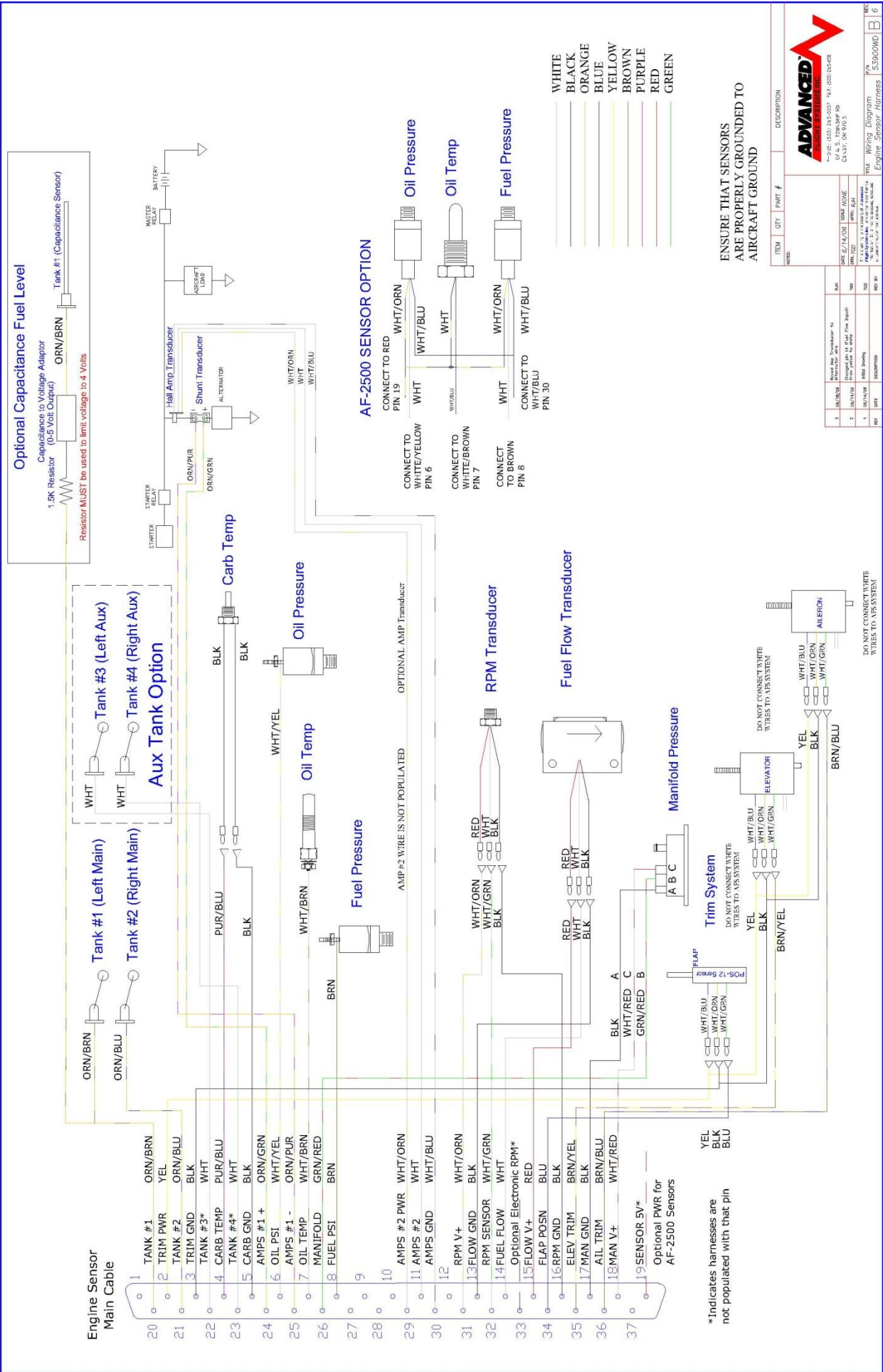

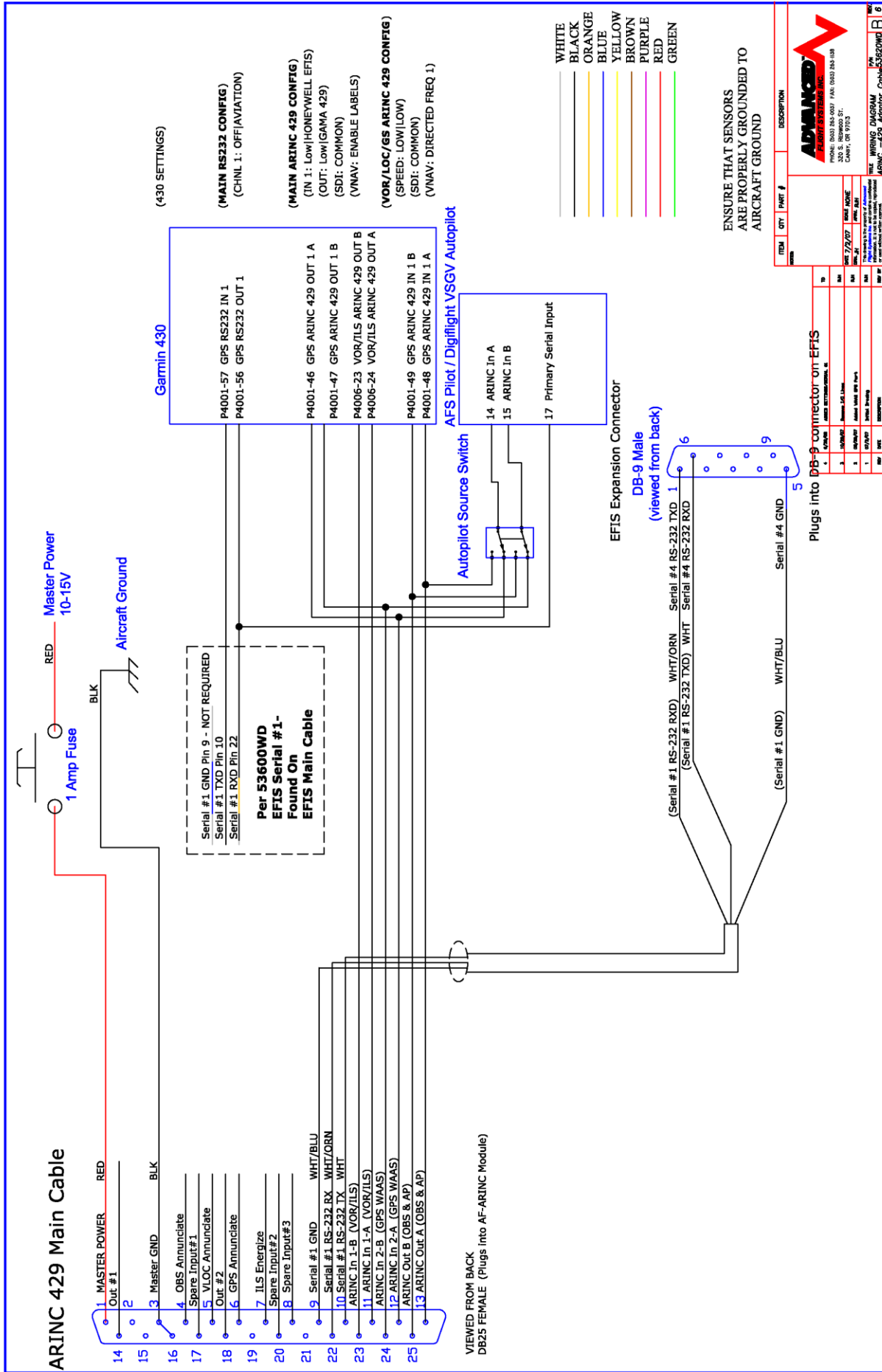

Registration Information

To receive important notification of Service Bulletins, and service difficulty reports, please

Email to:

info@advanced-flight-systems.com

Or mail to:

Advanced Flight Systems Inc.
320 S. Redwood St.
Canby OR 97013 USA

Owner's Name: _____

Address: _____

City: _____

State: _____ Postal Code ZIP: _____

Country: _____

Home telephone: _____

Business Telephone: _____

E-mail: _____

Aircraft Model and N#: _____

Engine Model : _____

System Model #: _____ Serial Number: _____

Installer: _____